



UC Series
Translation of the original operating instructions

Table of contents

1	Introduction	4
1.1	About these operating instructions	4
1.2	Copyright	4
1.3	Proper use	4
1.4	Improper use	4
1.5	Symbols used	5
2	Safety notes	6
2.1	Operator obligations	6
2.2	User obligations	6
2.3	Qualification requirements for personnel	6
2.4	Mechanical dangers	7
2.5	Electrical dangers	7
2.6	Thermal dangers	7
2.7	Handling of chemicals	7
2.8	Maintenance, repair and spare parts	8
3	Machine description	9
3.1	Description of function	9
3.2	Overview	9
3.3	Display	11
3.4	Washing programmes	11
3.5	Optional programmes and wash modes	12
3.6	Info menu	13
3.7	Chemicals	13
3.8	Suction tube with level control	13
3.9	Technical data	14
4	Software	15
4.1	Dishwashing staff menu	15
4.2	Chef menu	15
4.2.1	Hygiene logbook	16
4.2.2	Operating data	16
4.2.3	Water hardness	17
4.2.4	Dosage	17
4.2.5	Timer	19
4.2.6	Wash mode	20
4.2.7	Pictograms	21
4.2.8	Basic cleaning	21
4.2.9	Descale	22
4.2.10	Brightness	23
4.2.11	Sounds	23
4.2.12	Date / time	23
4.2.13	Language	23
4.2.14	Units	24
4.2.15	CONNECTED WASH	24
4.2.16	Water back-flow counter	24
4.2.17	Activated carbon filter	24
5	Commissioning	25
5.1	Installing the warewasher	25
5.2	Connecting the warewasher	25

5.2.1	Water connection	25
5.2.2	Electrical connection	27
5.3	Connecting suction tubes and external dosing devices	31
5.4	Establish the electrical connection of the external dosing devices	32
5.5	Configuring the transfer strip	33
5.6	Before working with the warewasher for the first time.....	34
5.7	Putting a preserved warewasher back into service.....	34
6	Operation	35
6.1	Switch on the warewasher	35
6.2	Check for completeness.....	35
6.3	Washing	35
6.4	Soaking programme.....	37
6.5	Changing the tank water	38
6.6	Switching off the warewasher	38
7	Notifications.....	39
7.1	Pictograms	39
7.2	Display the error code for a serious error.....	40
7.3	Poor wash result	40
8	Cleaning and maintenance.....	41
8.1	Cleaning the warewasher at the end of the working day	41
8.2	Topping up the regeneration salt	43
8.3	Refilling the detergent and rinse aid.....	44
8.4	Replacing the canister.....	45
8.5	Changing the chemical product.....	46
8.6	Descaling the warewasher	46
8.7	Changing the activated carbon filter.....	46
8.8	Maintenance by the customer service department	47
9	Disassembly and disposal	48
9.1	Taking the warewasher out of operation for long production stops.....	48
9.2	Disassembly.....	48
9.3	Disposal	48
10	Annex	49
10.1	Declaration of Conformity.....	49

1 Introduction

1.1 About these operating instructions

This operating manual constitutes a component of the warewasher and must be stored in a place that is accessible to the user. To be able to work safely with the warewasher, the safety and operating instructions provided must be observed. Compliance with the valid national accident prevention regulations and general safety provisions must be ensured.

1.2 Copyright

The instructions are protected for the manufacturer by copyright.

The instructions contain guidelines and drawings or parts of drawings of a technical nature, which must not be reproduced, distributed, or used for the purpose of competition without authorisation, nor shared with third parties, either in whole or in part.

The operator of the warewasher is permitted to make copies, in whole or part, expressly for internal use relating to the operation of the dishwasher. The manufacturer is entitled to claim damages for any infringements. Further rights are reserved.

Subject to technical alterations

© 2022 by Winterhalter Gastronom GmbH

1.3 Proper use

- The warewasher is intended only for washing dishes, cutlery, glasses, kitchen utensils, pots, trays, plates, and GN containers for gastronomic and similar use.
- Operate the warewasher with chemicals from Winterhalter. If other chemicals are used, contact Winterhalter or an authorised customer service team in advance.
- The warewasher is a technical device for commercial use and is not intended for private use.
- Only operate the warewasher as described in these operating instructions.

1.4 Improper use

- Do not wash without a wash rack.
- Do not wash electrical cooking appliances.
- Do not wash parts made of wood.
- Do not wash ashtrays or objects covered with wax.
- Only wash heat-resistant plastic parts and those resistant to alkalis.
- Do not make any changes, additions or modifications without the approval of the manufacturer.
- Winterhalter Gastronom GmbH assumes no liability for any damage caused by improper use of the warewasher.

1.5 Symbols used

- This symbol indicates an instruction.
 - ⇒ This symbol indicates the results of your actions.
- This symbol indicates a list.

Note: Indicates an additional important piece of information.

The following symbol refers to additional information: ▶ page 6

Warning notices have the following layout:



CAUTION

Type and source of danger

Consequences of danger

- Measures to avert the danger.

The danger level is indicated by the signal word.



DANGER

The signal word DANGER indicates an immediate danger; ignoring it will lead to serious injury or death.



WARNING

The signal word WARNING indicates a potential danger; ignoring it may lead to serious injury or death.



CAUTION

The signal word CAUTION indicates a potential danger; ignoring it may lead to minor or moderate injury.



NOTE

The signal word NOTE indicates potential damage to property.

2 Safety notes

Winterhalter Gastronom GmbH assumes no liability or warranty in the event of non-compliance with these safety and operating instructions.

2.1 Operator obligations

The commercial warewasher is used in the restaurant industry and similar businesses (bakeries, butcher's shops, etc.). The operator of the warewasher is therefore subject to the legal obligations for occupational safety. In addition to the warning and safety information in these operating instructions, the operator must comply with the current provisions regarding safety, accident prevention and environmental protection for the area of application of the warewasher. To ensure safe use of the warewasher, the operator must take the following measures:

- Arrange for the warewasher to be connected by authorised technicians according to the locally applicable standards and regulations.
- Provide the user with information on the provisions regarding occupational safety.
- Ensure that only personnel who have read and understood the operating instructions and safety notes and are trained in handling the warewasher and the chemicals work with them.
- Refer users to the safety notes and inform them of potential dangers. Repeat training sessions at regular intervals to prevent accidents.
- Arrange for the Winterhalter customer service team or a specialist dealer to provide instruction in operating and using the warewasher.
- Provide the user with the operating instructions and quick guide.
- Operate the warewasher only when it is in perfect technical and hygienic condition.

2.2 User obligations

In addition to the warning and safety information in these operating instructions, the operator must comply with the current provisions regarding safety, accident prevention and environmental protection for the area of application of the commercial warewasher.

In particular, the user must take the following measures:

- Adhere to the applicable occupational safety regulations.
- Follow the allocated responsibilities for installation, operation, maintenance and cleaning of the warewasher.
- Read the operating instructions and safety notes.
- Only work on the warewasher after receiving training in handling the warewasher and the chemicals.
- Operate the warewasher only when it is in perfect technical and hygienic condition.
- Switch off the warewasher immediately should a malfunction occur.
Switch the warewasher back on only once the cause of the malfunction has been remedied by an authorised service technician.
- Ensure cleanliness and tidiness around the warewasher.
- Once the work is complete, turn off the on-site water supply.

2.3 Qualification requirements for personnel

Activity	User group	Qualification / training
Connection to the mains supply	Specialist personnel	Authorised electrician or personnel with equivalent qualification
Installation, initial commissioning, maintenance, repair, recommissioning	Specialist personnel	Electrician with Winterhalter training or Winterhalter service technician with training as an electrician or personnel with equivalent qualification
Operation, cleaning and maintenance in daily use	Adults	Instruction and briefing regarding dangers provided by the operator, based on the operating instructions (quick guide and safety notes)
	Young people over the age of 14	Instruction and briefing regarding dangers provided by the operator, based on the operating instructions (quick guide and safety notes) Under supervision
	Children under the age of 14	Not permitted

2.4 Mechanical dangers

- In order to avoid the risk of slipping on wet floors when operating the warewasher, prevent dirt from accumulating on the floor and wear non-slip footwear.
- In order to avoid cutting injuries on sharp metal edges, wear protective gloves for assembly and repair work.
- Rusting foreign bodies inside the warewasher can cause even “rust-free stainless steel” to corrode. Use only undamaged wire grate baskets, rust-free wash items and suitable cleaning utensils to ensure that water pipes are protected from rust.
- Do not sit or stand on the open door of the warewasher, to prevent it from tipping over.
- In the case of installation and operation in vehicles, follow the additional requirements for unstable surfaces.

2.5 Electrical dangers

- The connection to the electrical mains supply may be made only by a specialist company registered within the electrical trade and approved by the energy supplier.
- Work on the electrical system, installation and maintenance work and repairs may be carried out only by qualified specialists. The electrical engineering safety rules must be observed to avoid electrical accidents:
 - Disconnect all power supply points.
 - Secure the machine to prevent it from being switched on again.
 - Check that there is no voltage present.
 - Earth and short circuit.
 - Cover or cordon off neighbouring parts that are live.
- Do not open any machine covers or machine parts if doing so requires tools. There is a danger of electric shock.
- The electrical safety of this machine is guaranteed only if it is connected to a correctly installed protective circuit. Winterhalter cannot be held responsible for damage caused by a missing or broken protective conductor (e.g. electric shock).
- If the mains cable is damaged, it must be replaced by Winterhalter, its customer service team or another qualified person to prevent danger. The mains cable must be a H07RN-F type or equivalent.
- Machines delivered from the factory fitted with a mains cable and safety plug may be connected only to an individually protected safety socket. Do not use extension cables or multi-socket adapters.
- Touching live components can lead to death by electric shock. In the event of a defect or damage to an electrical component / cable or its insulation, switch off the power supply immediately and arrange for its repair by a specialist.

2.6 Thermal dangers

- Contact with hot components and surfaces can cause burns.
 - Before installation and maintenance work and repairs, allow the warewasher and surfaces to cool down.
 - Wear protective clothing and gloves.
- When fitting additional devices, lay electrical cables and dosing hoses a sufficient distance away from hot components to prevent damage.
- Do not operate the warewasher below 0°C to avoid damage to the hoses, tank and boiler and prevent functional damage.

2.7 Handling of chemicals

Contact of chemicals with the skin or eyes can lead to severe burns, eye damage and poisoning.

- In the event of contact with the eyes or skin, wash thoroughly with tap water and seek medical attention if necessary.
- Never drink chemicals or wash water or transfer them to other storage containers.
- Wear protective clothing, protective gloves and protective goggles when working with chemicals.
- Observe the danger and safety notes on the canister and safety data sheet.

2.8 Maintenance, repair and spare parts

- Only service technicians who have been trained and authorised by Winterhalter are permitted to carry out maintenance work and repairs. Improper maintenance or repairs may cause significant danger to the user, for which Winterhalter cannot assume liability.
- Only original Winterhalter spare parts may be used for maintenance and repairs. If original spare parts are not used, the warranty is invalidated. The information in the spare parts catalogue is definitive in this respect.
- Arrange for an installer or an electrician to remedy on-site water and electricity supply malfunctions. Arrange for other malfunctions to be remedied by an authorised service technician or dealer.

3 Machine description

3.1 Description of function

After the warewasher is switched on, the boiler and the tank are filled and heated up to the operating temperature. Once the target temperatures are reached, the warewasher is ready for use.

The warewasher is fully automatic with programmes consisting of three steps: Wash, Drain and Rinse.

3.2 Overview

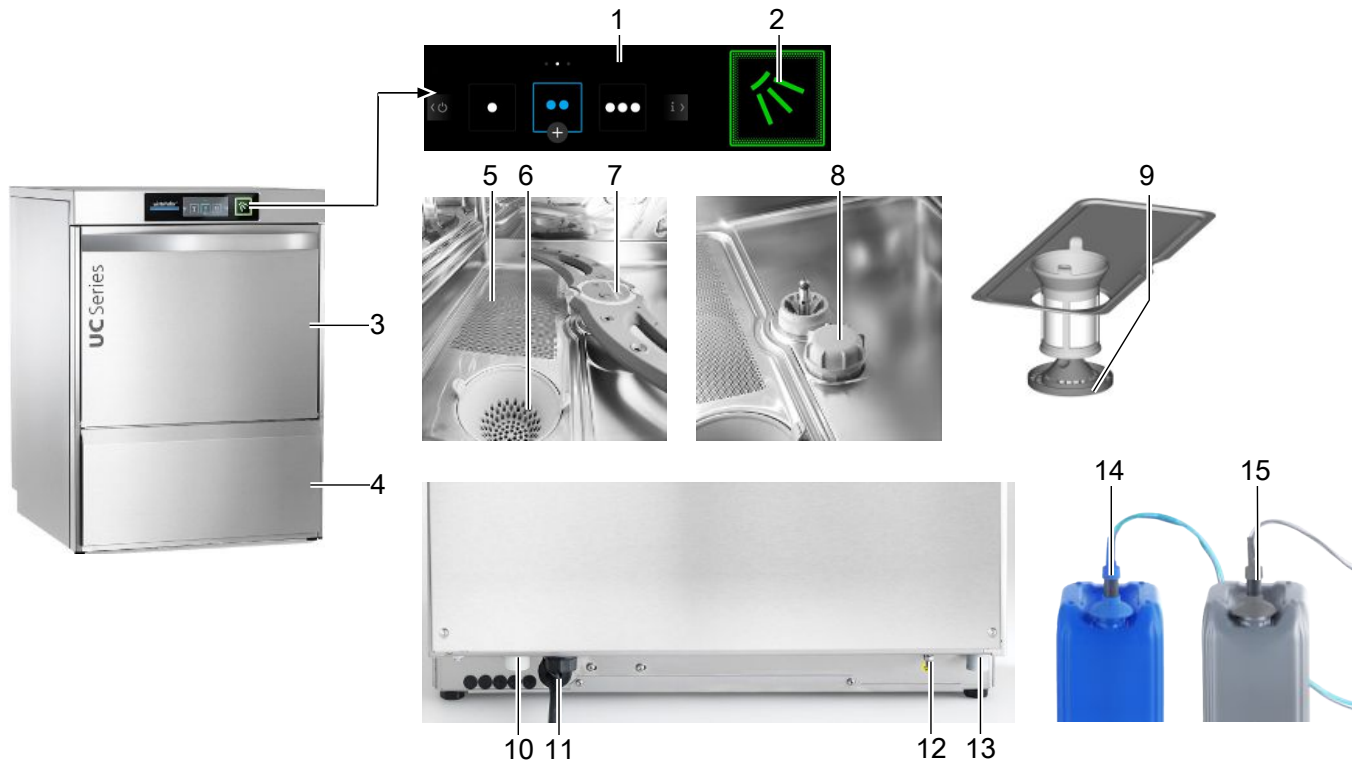

Item	Description	Item	Description
1	Display	9	Filter bottom
2	Start button	10	Connection for supply hose
3	Door	11	Mains cable
4	Integral storage tanks for rinse aid and detergent (optional)	12	Connection for on-site equipotential bonding system
5	Strainer	13	Connection for waste water hose
6	Filter cylinder	14	Suction tube for rinse aid (optional)
7	Lower wash field	15	Suction tube for detergent (optional)
8	Integral water softener (optional)		

Energy (optional)

Note: Cold water connection required.

The Energy module of the warewasher includes a fan motor and a heat exchanger. The fan motor extracts the moist and warm air (= vapours) out of the washing compartment and transfers the generated energy to the cold inlet water via a heat exchanger.

Cool (optional)

Note: Cold water connection required.

The rinse temperature can be changed for warewashers with this option. Glasses are ready to be used again faster with cold rinsing.

Integral water softener (optional)

Warewasher with built-in salt container for regeneration salt. The regeneration salt softens the inlet water and thus prevents a build-up of limescale inside the warewasher and on the items being washed.

Excellence-i(Plus) (optional)

Note: Cold water connection required.

A reverse osmosis device is fitted in Excellence-i warewashers. Reverse osmosis removes substances that have dissolved in the water. The largely limescale and mineral-free osmosis water prevents any deposits on glasses, dishes and cutlery and delivers wash results that do not require polishing. Excellence-iPlus warewashers also have an integrated water softener.

PAY PER WASH (optional)

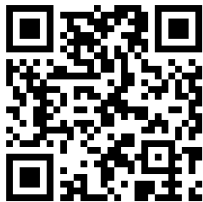

Further information is available on our homepage.
www.pay-per-wash.com

CONNECTED WASH



Further information is available on our homepage.
www.connected-wash.com

3.3 Display

Operating the display is similar to operating the display of a smartphone. The display responds to light touches. Therefore, only operate the display with your fingers and do not use any sharp objects. You can also operate the display and start button with wet hands or rubber gloves.

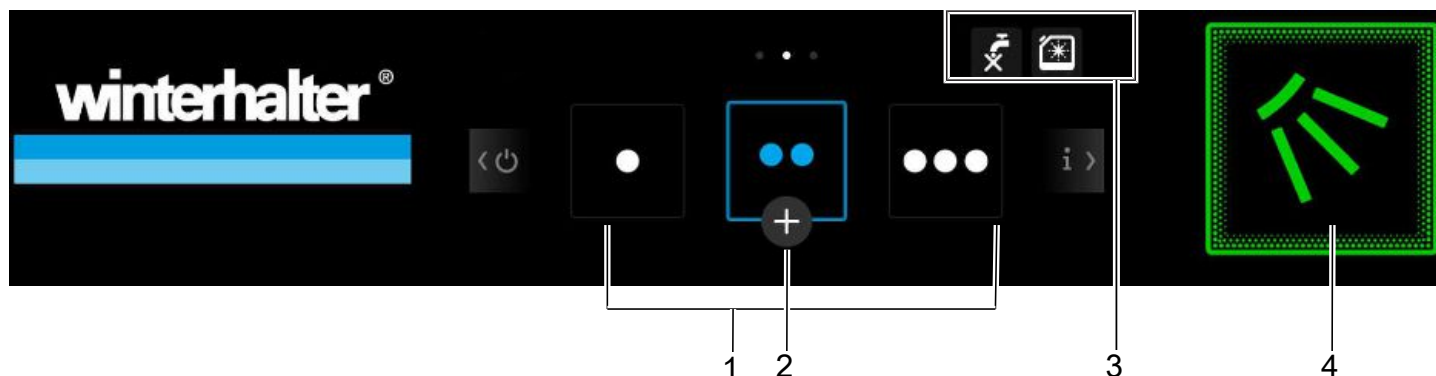

Item	Name
1	Washing programmes
2	Selection of additional programmes
3	Display area for error pictograms
4	Start button

Start button (4)

Colour	Meaning
No light	Washer is switched off.
Orange	Washer is filling and heating up.
Green	Washer is ready for use.
Flashing green	Washing programme has ended; door has not yet been opened.
Blue	Washer is washing.
Flashing blue	Soaking programme is running.
Flashing green-blue	Only for washers with Energy module: warm and humid air is being extracted. The washing programme is complete only when the start button flashes green.
Red	The washer has stopped washing because there is a serious error.











Screen saver



The display is dimmed if it is not used for a long time. Washing can also be carried out when the display is darkened.



3.4 Washing programmes

The washing programmes differ depending on the type of washer, as they are adapted to the respective wash items. The authorised service technician can adjust programmes (temperature, wash pressure, dosing, and programme length). Programme 2 is pre-selected as soon as the washer is ready for operation.

Additional pictograms are available via the chef menu.

Washer type	Programme 1	Programme 2	Programme 3
Dishwasher	 Slightly dirty dishes	 Moderately dirty dishes	 Very dirty dishes
Glasswasher	 Delicate glasses	 Glasses	 Robust glasses
Bistro washer	 Glasses	 Glasses and cups	 Plates
Cutlery washer	-	 Cutlery	-



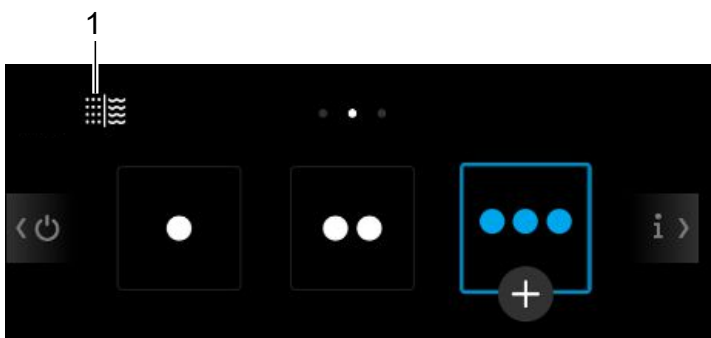

Pictogram / additional programme	Meaning
 Intensive programme	Longer wash time for heavy soiling
 Silence programme	Quieter washing programme that uses reduced wash pressure and longer wash time
 ECO programme	Longer wash time with reduced use of resources
 Short programme	Shortened wash time with slightly higher detergent consumption
 Soaking programme	Programme for soaking and dissolving dried-on residues (▶ page 37)

Pictogram / special programme	Meaning
 Basic cleaning programme	Menu-guided programme for the thorough cleaning of glasses and wash items, e.g. to remove starch residues (▶ page 21)
 Descaling programme	Menu-guided programme for descaling the inside of the ware-washer (▶ page 22)

3.5 Optional programmes and wash modes



Item	Description
1	Display of activated optional programme and wash mode

Pictogram / programme	Meaning
 Excellence-i(Plus) only: Reverse osmosis	Rinsing with osmosis water activated in the selected washing programme
 Excellence-i(Plus) only: Reverse osmosis	Osmosis water is produced, the duration of the washing programme is increased and additional water is consumed
 Wash mode A0-30	Wash mode A0-30 is activated.
 Wash mode A0-60	Wash mode A0-60 is activated.

Note: When switching to rinsing with osmosis water, the boiler of the warewasher is flushed out. All washing cycles using rinsing with osmosis water should be run together, as flushing out the boiler consumes additional water and increases the time of the washing programme.

3.6 Info menu

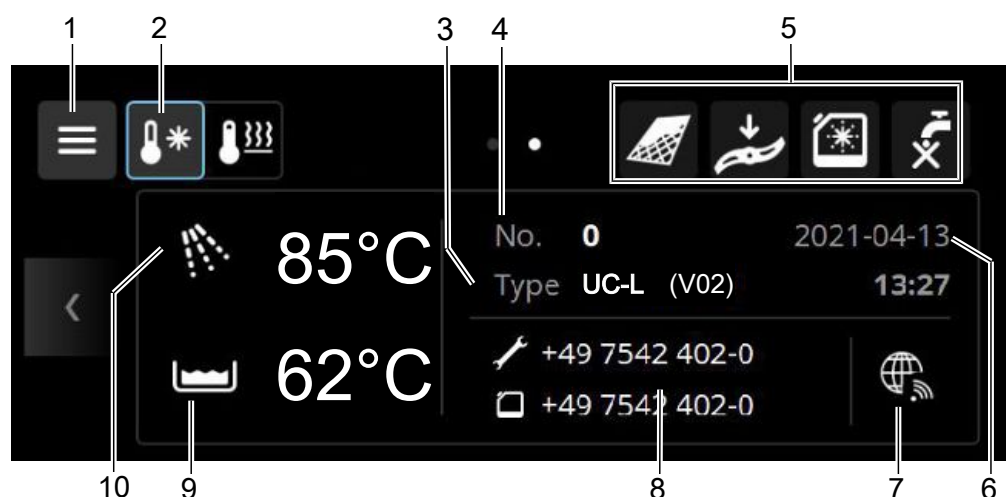

Item	Description
1	Access to the dishwashing staff menu / chef menu
2	Cool (optional): Switching the rinse water temperature
3	Machine model
4	Machine number
5	Display area for error pictograms
6	Date / time
7	CONNECTED WASH: The warewasher is connected to the internet
8	Telephone number for service technician and chemical supplier
9	Current tank temperature
10	Current rinse water temperature

3.7 Chemicals

Operate the warewasher with chemicals from Winterhalter. If other chemicals are used, contact Winterhalter or an authorised customer service team in advance. Only use products that are suitable for commercial warewashers.

Rinse aid

Rinse aid is required in order to ensure that water on the wash items runs off as a thin film after washing. This ensures that the wash items dry quickly.

Rinse aid is automatically dispensed using an integrated or external dosing device.

Detergent

A detergent is required to dissolve food residues and dirt on the wash items. Detergent is automatically dispensed using an integrated or external dosing device.

To avoid damaging the warewasher and to achieve a good wash result:

- Do not use acidic detergents.
- Do not use foaming products (e.g. manual washing-up liquid) for pre-treating the wash items.

3.8 Suction tube with level control

Note: Only for machine with external canisters.



Colour (cover cap)	Canister
Blue	Rinse aid (optional)
Grey	Detergent (optional)

The float switch (1) can detect a defect in the chemicals and indicates this on the display (► page 39).

3.9 Technical data

Name	Note	Unit	Value			
			UC-S	UC-M	UC-L	UC-XL
Rack dimensions		mm	400 x400	500 x 500	500 x 500	500 x 500
						500 x 540
Tank capacity		l	9.5	15.3		
Noise emission	Standard, Cool Energy	dB(A)	55			
	Excellence-i(Plus)		62.5			
IP protection class	Plastic rear panel		IPX3			-
	Stainless steel rear panel		IPX5			
Min. water flow pressure	Standard, Cool	kPa (bar)	100 (1.0)			
	Energy		150 (1.5)			
	Excellence-i(Plus)		140 (1.4)			
Max. inlet pressure (back pressure)		kPa (bar)	1000 (10.0)			
Flow rate	Standard, Cool Excellence-i(Plus)	l/min	min. 4			
	Energy		min. 3			
Inlet water temperature	Standard	°C	max. 60			
	Cool Energy		max. 20			
	Excellence-i(Plus)		max. 35			

Exhaust air

Observe local guidelines, e.g. DIN EN 16282 / VDI guideline 2052 when constructing the ventilation system.

Operating conditions



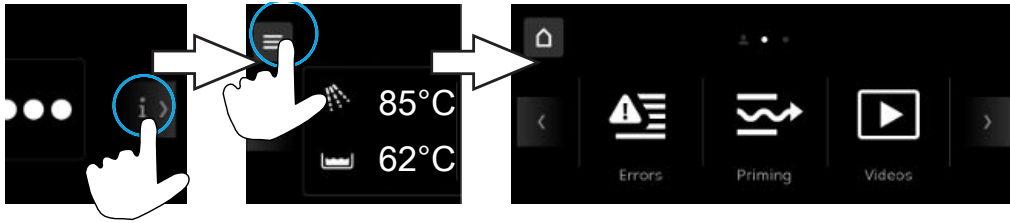

Name	Unit	Value
Temperature at the installation site	°C	0 - 40
Relative air humidity at the installation site	%	< 95
Storage temperature	°C	> -25
Max. height of the installation location above sea level	m	3000

4 Software

4.1 Dishwashing staff menu



The following menus are available:

Menu	Functions
 Error log	List of current errors and history of corrected errors
 Priming	Priming of the dosing device
 Videos	Instructional videos
 Addresses	Addresses of service technicians and suppliers for rinse aid and detergent
 PAY PER WASH	Enter PAY PER WASH information and wash codes (optional)

4.2 Chef menu

In this menu the chef can change settings to the warewasher and access information. The warewasher switches off when the menu is accessed. After leaving the menu, the warewasher must be switched back on.

Accessing the chef menu

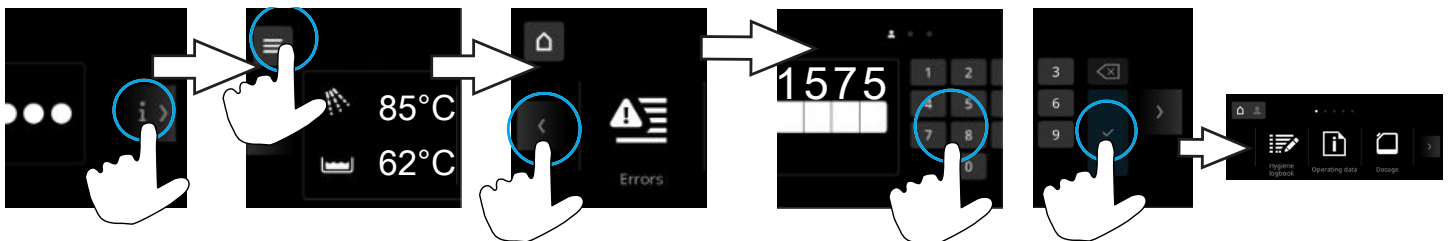

















A PIN protects the menu from unauthorised access. The PIN is 1575. If you enter your PIN incorrectly three times in a row, input will be blocked for 10 minutes.

Navigation



Item	Name
1	Continue to the next window by tapping or "swiping"
2	Exit the menu
3	"Chef menu" symbol
4	Number of windows at the same level
5	One level back
6	Scroll up or down

The following menus are available:

Menu	Menu
 Hygiene logbook	 Brightness
 Operating data	 Sounds
 Water hardness	 Date / time
 Dosage	 Language
 Timer	 Units
 Wash mode	 CONNECTED WASH
 Pictograms	 Water countdown meter
 Basic cleaning	 Optional Excellence-i(Plus) Activated carbon filter
 Descaling	

The number of menus depends on the configuration of the warewasher.

4.2.1 Hygiene logbook

In this menu, the daily operating statuses are shown in chronological order.

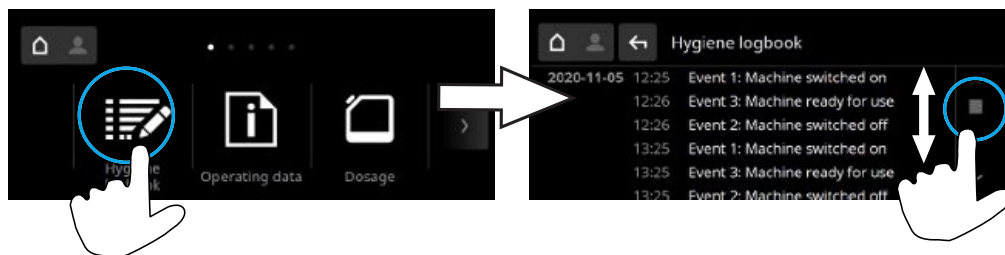

4.2.2 Operating data

In this menu the operating data, e.g. consumption values and operating hours, are shown. Water consumption values are reference values and are not based on precise measurements.

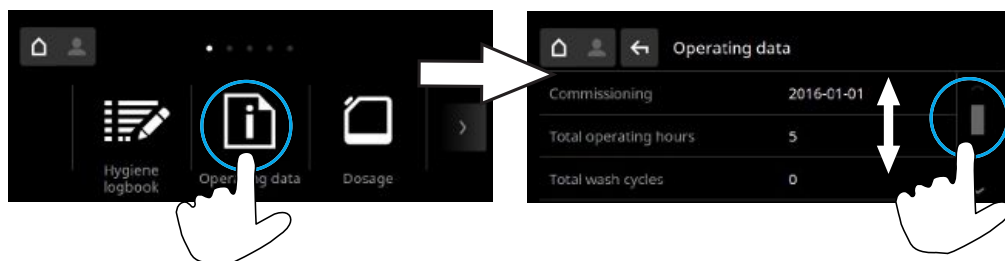

4.2.3 Water hardness

Note: Only for machines with an integral water softener.

The water hardness of the inlet water is entered in this menu.

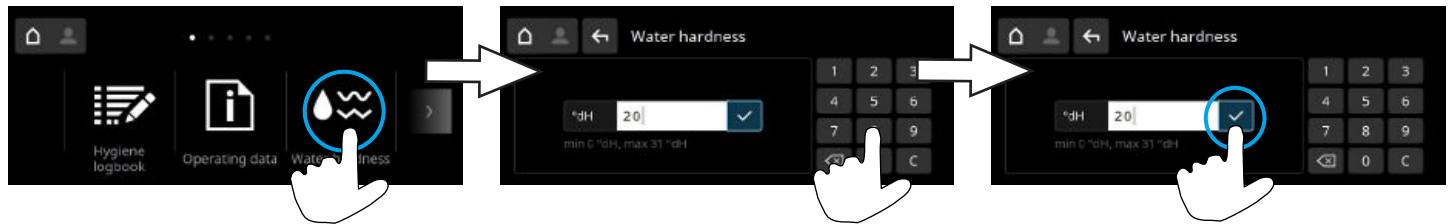

Calculation table

		°dH	°e	°TH	mmol/l
German hardness	1°dH=	1.0	1.253	1.78	0.179
English hardness	1°e=	0.798	1.0	1.43	0.142
French hardness	1°TH=	0.560	0.702	1.0	0.1
mmol/l	1 mmol/l=	5.6	7.02	10.0	1.0

4.2.4 Dosage

In this menu you set the dosing amounts and configure the transfer strip for the dosing devices.

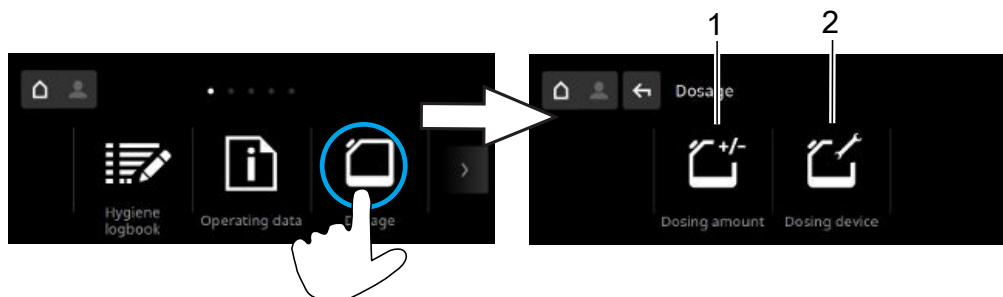

Item	Name
1	Set the dosing amount
2	Configure the transfer strip ▶ page 33

Setting the dosing amount

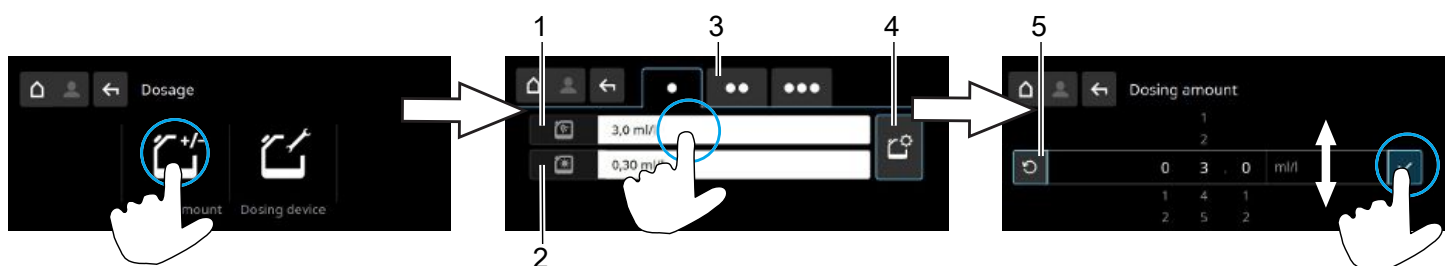

Item	Description
1	Detergent dosing
2	Rinse aid dosing
3	Washing programmes
4	Chemicals database
5	Reset to default setting

Accessing the chemicals database

When using Winterhalter rinse aid and detergent, the canisters incorporate the information for a detergent group (e.g. DT05) or rinse aid group (e.g. RA01). This information is used as an aid for dosing. However, we recommend that the dosing setting be set precisely by an authorised service technician.

Note: Canisters with 'DT' or 'RA' information are not available in all countries.



Item	Description
1	Detergent group (DT)
2	Rinse aid group (RA)
3	Water hardness

Setting the detergent group

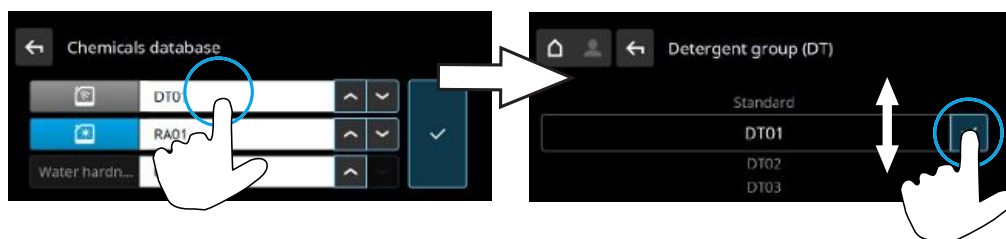

Setting the rinse aid group

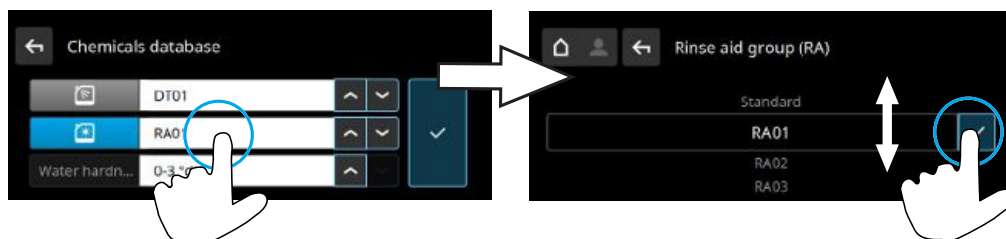

Setting the water hardness

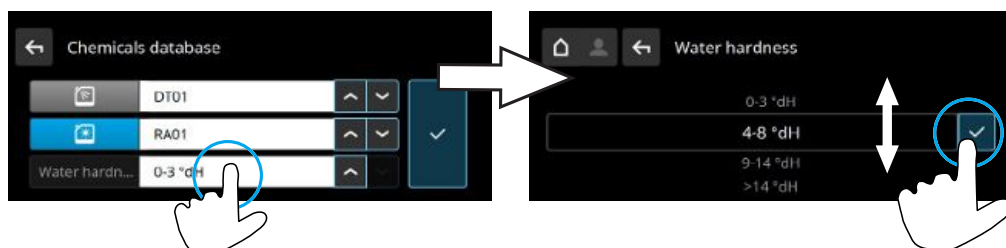

Calculation table

Note: Enter water hardness in °dH. Set "0-3 °dH" for machines with a built-in water softener.

		°dH	°e	°TH	mmol/l
German hardness	1°dH=	1.0	1.253	1.78	0.179
English hardness	1°e=	0.798	1.0	1.43	0.142
French hardness	1°TH=	0.560	0.702	1.0	0.1
mmol/l	1 mmol/l=	5.6	7.02	10.0	1.0

Exit the menu



4.2.5 Timer

The timer can be used to programme the warewasher to switch on or off automatically at a specific time. At the time of automatic start-up, the following requirements must be met:

- The door is closed.
- The local mains disconnector is switched on.
- The local water supply is open.

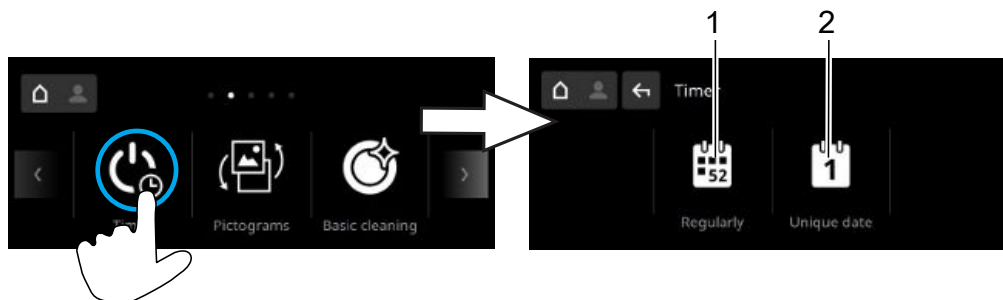

Item	Name
1	Set a regular time
2	Set a non-recurring date

Setting a regular time

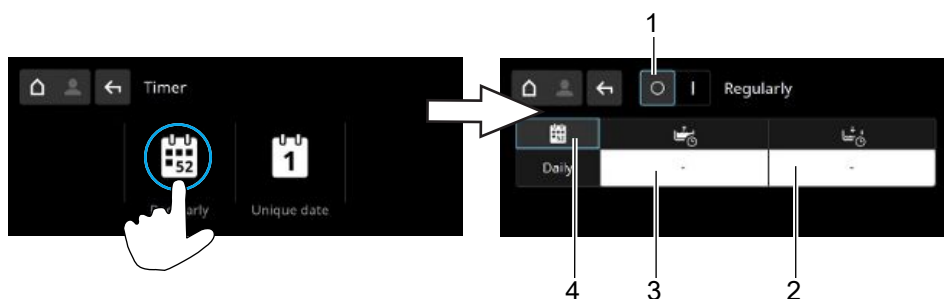

Item	Name
1	Switch the timer off/on
2	Time for automatic switch-off
3	Time for automatic start-up
4	Select timer schedule <ul style="list-style-type: none"> – Daily – Mon–Fri, Sat–Sun – Individual (a different time on each weekday)

Setting a non-recurring date

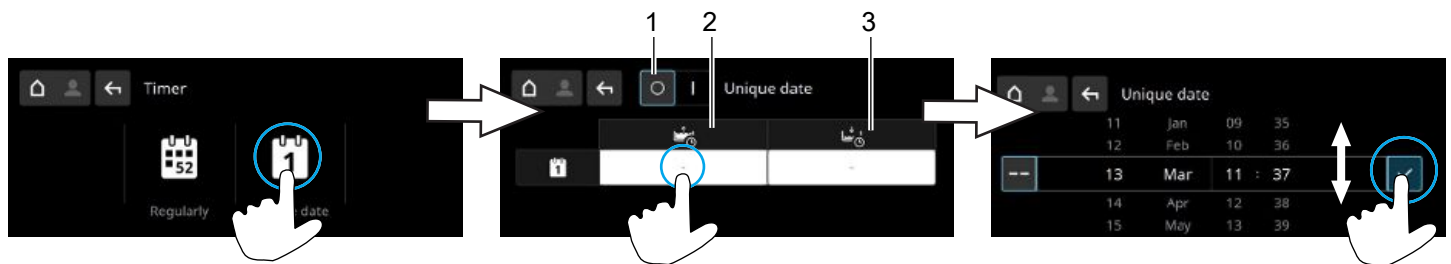

Item	Name
1	Switch the timer off/on
2	Date and time for automatic start-up
3	Date and time for automatic switch-off

Automatic switch-off sequence

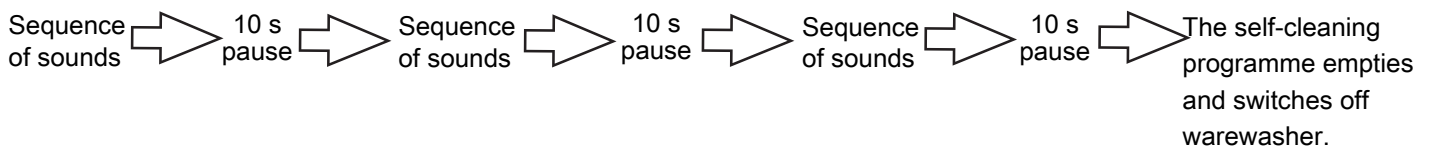

If the door is open during the automatic switch-off, the warewasher is pumped empty and switched off, but is not cleaned on the inside.

Showing the programmed time



4.2.6 Wash mode

In this menu, the wash mode can be set.

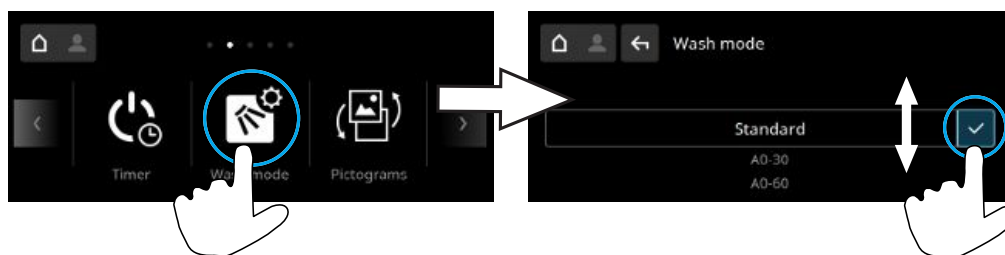

Standard

In the standard wash mode, the washing programmes are adjusted to the wash items. All additional programmes can be selected.

A0-30 and A0-60

Note: Not possible with activated external energy management or with Cool option warewasHERs.

In the A0-30 and A0-60 wash modes, the washing programmes are adjusted to the A0 requirements by means of increased temperature and an extended wash time. The modes can thus result in higher energy consumption and a longer wash time. If the A0 values are not fulfilled, the washing process stops after 20 minutes. The Intensive, Silence, ECO and Short programmes cannot be selected.

4.2.7 Pictograms

The pictograms for the 3 washing programmes can be changed in this menu.

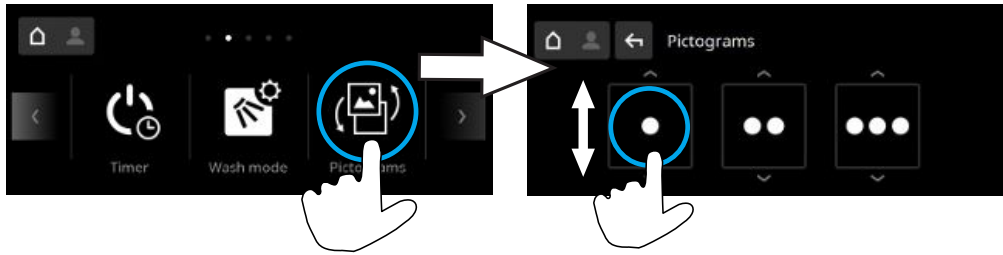

Changing the pictograms has no effect on parameters such as programme length or temperatures.

4.2.8 Basic cleaning

The menu-guided basic cleaning programme is used for the thorough cleaning of wash items:

- Removal of starch residues from dishes
- Basic cleaning of new glasses
- Removal of residues on glasses

We recommend running the basic cleaning programme at the end of the working day, as the machine's tank is emptied when the programme ends. This programme requires a basic cleaner that is suitable for commercial warewashers. For dishes, Winterhalter recommends the A 20 ST basic cleaner, and for glasses the A 25 GL basic cleaner.



WARNING

Risk of chemical burns due to chemicals

Contact of chemicals with the skin or eyes can lead to severe burns or serious eye damage.

- In the event of contact with the eyes or skin, wash thoroughly with tap water. If necessary, seek medical attention.
- Wear protective clothing, protective gloves and protective goggles.
- Observe the danger and safety notes on the canister and safety data sheet.

Starting the basic cleaning programme

Follow dosing recommendations when adding the basic cleaner. The initial dose for the first use of the programme depends on the machine's tank volume.

The post-dosing for each additional programme depends on the rinse water volume.

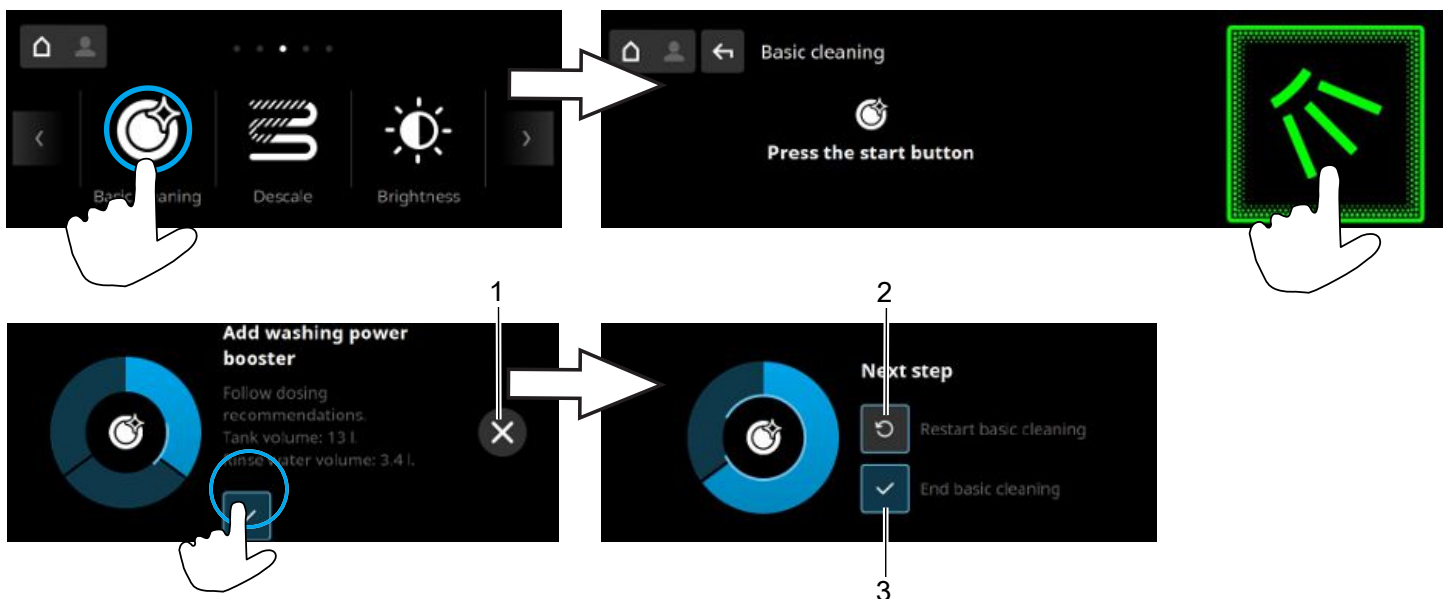

Item	Name
1	Cancel basic cleaning programme
2	Restart basic cleaning programme
3	End basic cleaning programme

4.2.9 Descale

If the warewasher is operated with hard water and without water treatment, then the boiler, the interior of the machine, all the water lines and components may develop scale. Limescale deposits and dirt that remain in the machine can contribute towards hygiene risks, while scaling can lead to failure of heating elements. In case of limescale deposits, the warewasher must be descaled.

Using the descaling programme (▶ page 22), scale is removed from the inside of the warewasher. We recommend running the descaling programme at the end of the working day only, as the machine's tank is emptied when the programme starts and ends.

The water lines and the boiler can only be descaled by an authorised service technician.

For descaling, you require an acid-based descaler suitable for commercial warewashers. Winterhalter recommends A 70 LS descaler.



WARNING

Risk of chemical burn due to contact with descaler

Contact between descaler and the skin or eyes can lead to severe burns or serious eye damage.

- Wear protective clothing, protective gloves and protective goggles.
- Observe the danger and safety notes on the canister and safety data sheet.



WARNING

Danger of chlorine gas developing

Mixing active chlorine cleaner and acid-based descaler produces chlorine gas. Contact with chlorine gas leads to eye, nose and throat irritations.

- Do not mix active chlorine cleaner and acid-based descaler.
- Ensure good ventilation when you descale the warewasher.



NOTE

Danger of corrosion due to descaler solution

Descaler solution has a corrosive effect when in contact with metals and plastics for a long time and therefore must not remain in the interior of the machine (e.g. overnight).

- Do not cancel the descaling programme and follow the instructions on the display.

Starting the descaling programme

When adding the descaler, observe the tank volume and dosing recommendation.

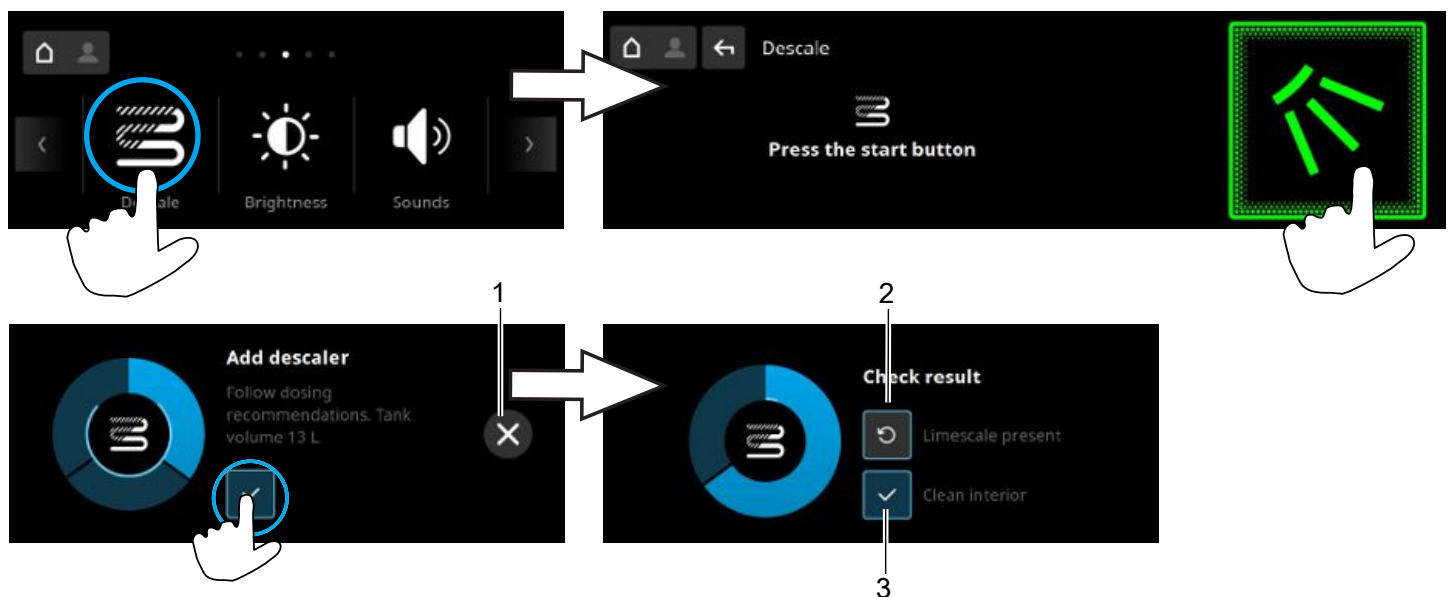

Item	Name
1	Cancel descaling programme (possible as long as no descaler has been added)
2	Repeat descaling programme
3	End descaling programme

4.2.10 Brightness

In this menu, the brightness of the display is set.

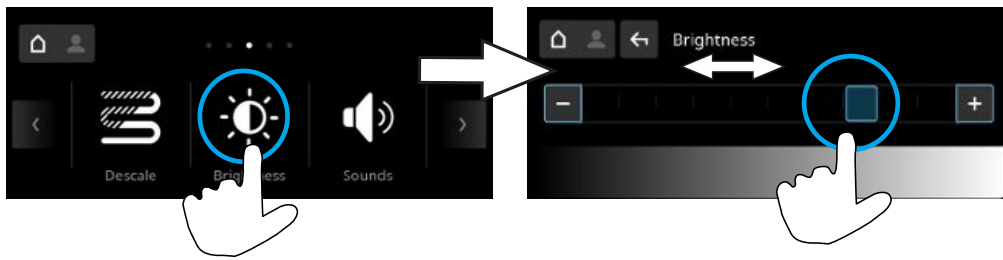

4.2.11 Sounds

In this menu sounds are turned on or off.

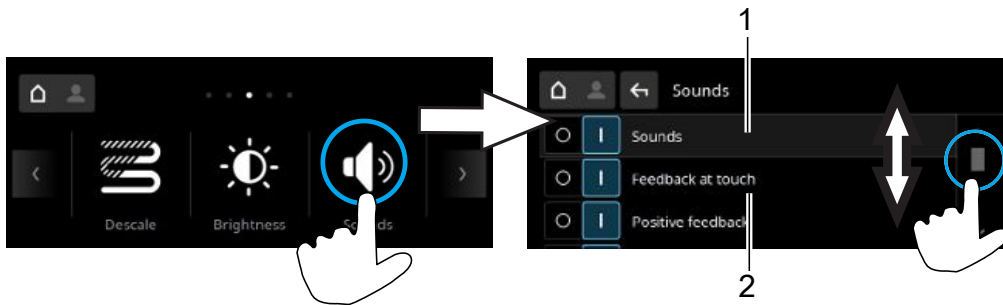

Item	Name
1	Turn all sounds on or off
2	Turn individual sounds on or off

4.2.12 Date / time

In this menu, the date and time are entered.

Note: Time must be changed for the summer/ winter time changeover.

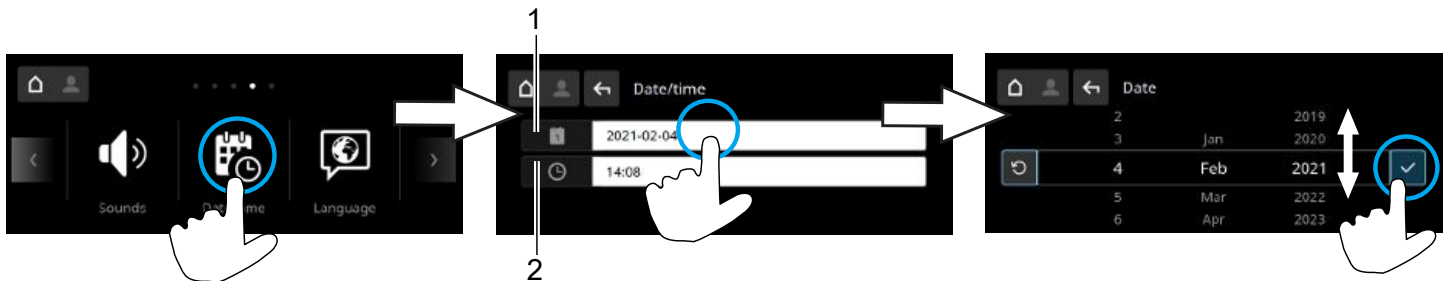

Item	Name
1	Set date
2	Set time

4.2.13 Language

In this menu the language of the display texts is set.

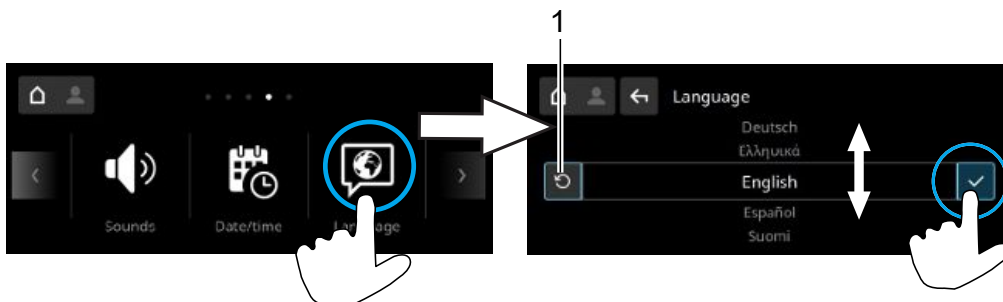

Item	Name
1	Reset to last language set

4.2.14 Units

In this menu the unit and temperature indicator are changed.

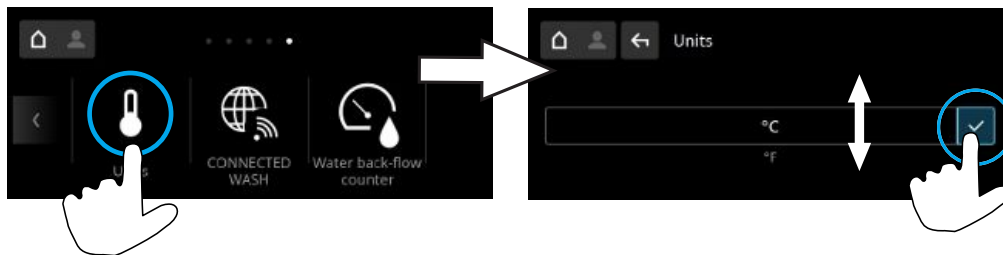

4.2.15 CONNECTED WASH

In this menu the link with CONNECTED WASH is configured.



Activating CONNECTED WASH

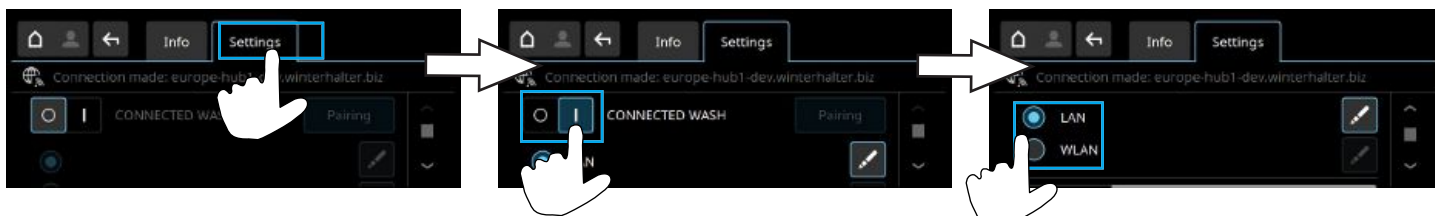

You will find detailed information and instructions on the website: ▶ page 10

4.2.16 Water back-flow counter

The water back-flow counter must be reset if the set total capacity of an external water treatment device has reached the value "0".

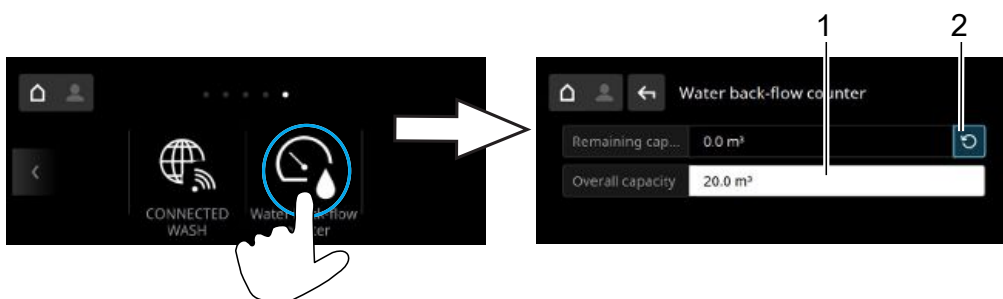

Item	Name
1	Set the total capacity
2	Reset the water back-flow counter

4.2.17 Activated carbon filter

Note: Only for Excellence-i(Plus) warewashers with an integrated reverse osmosis module.

In this menu, the counter must be reset after replacing the activated carbon filter.

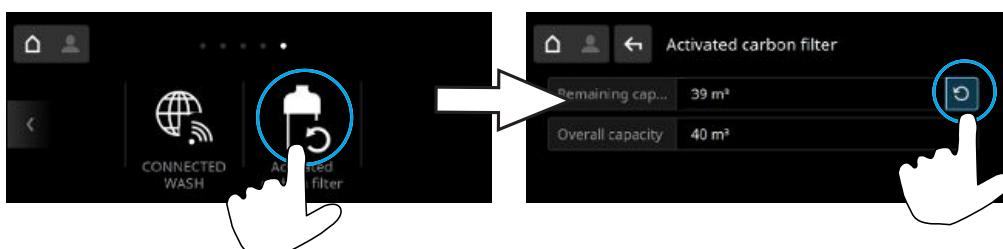

5 Commissioning

5.1 Installing the warewasher

The installation site must be frost-resistant to prevent the water supply systems from freezing.

- Install the warewasher horizontally using a spirit level.
- Adjust any unevenness of the base using the height-adjustable machine feet.

5.2 Connecting the warewasher

The warewasher and any other relevant additional devices must be connected in adherence to local standards and regulations by an electrical company authorised by the relevant electricity supplier.

5.2.1 Water connection

The warewasher must be connected to the fresh water supply via the provided dirt trap, in order to achieve the water safety level pursuant to DIN EN 61770.

The dirt trap prevents particles from the inlet water from entering the warewasher, thus preventing extraneous rust on the cutlery and in the warewasher.

Connecting the supply hose

Important notes:

- The supply hose must not be shortened or damaged.
- Only use the supply hose provided. Old, pre-existing supply hoses must not be re-used.
- Do not kink the supply hose when installing it.

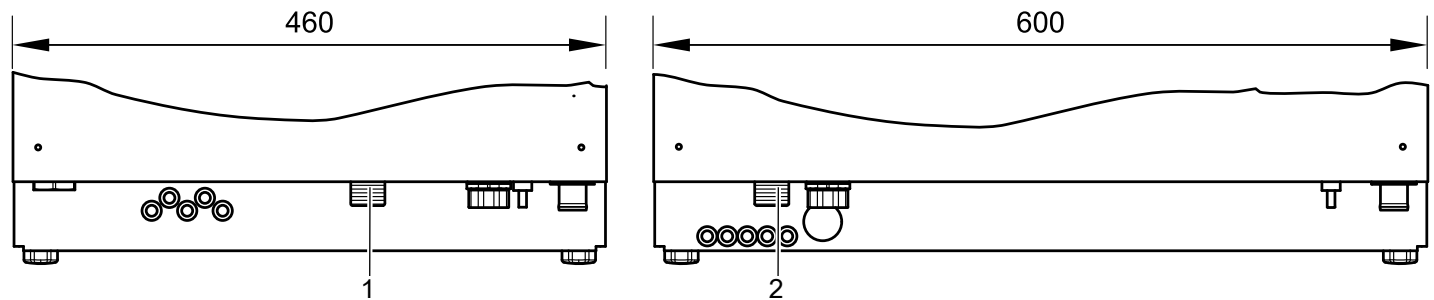

Item	Name
1	UC-S inlet water connection
2	UC-M, UC-L, UC-XL inlet water connection

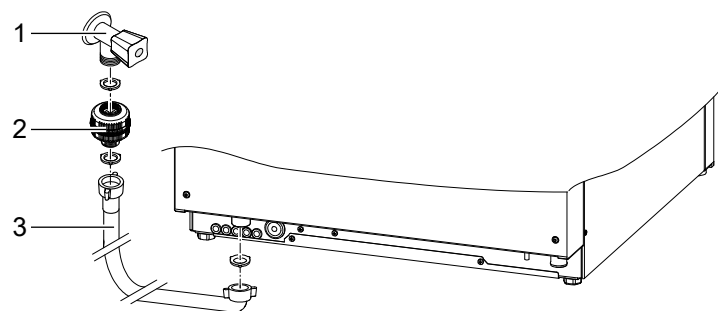

- Connect the supply hose (3) to the warewasher.
- Connect the dirt trap (2) to the local water supply (1).
- Connect the supply hose (3) to the dirt trap (2).
- Open the water supply (1) and check that the connections are sealed.

Connecting the warewasher to the waste water system

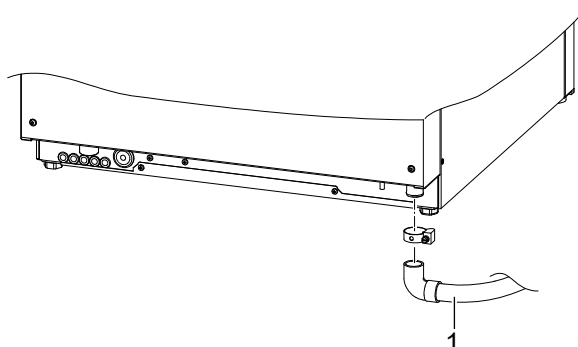

- Connect the waste water hose (1) to the warewasher.
- Guide and connect the waste water hose to the on-site waste water connection.

Requirements for on-site installation

Inlet water connection

Location	approx. 400 mm above finished floor; next to the machine		
Construction	Isolation valve with G ¾" external thread		
Inlet water temperature	UC Standard	max. 60°C	
	UC Energy, UC Cool	max. 20°C	
	UC Excellence-i, -i(Plus)	max. 35°C	
Water quality	Microbiologically, fresh water must be of drinking water quality		
Water hardness		Machines without integrated softener	Machines with integrated softener
	UC Standard UC Energy, UC Cool	≤ 3 °dH (3.8 °e / 5.34 °TH / 0.54 mmol/l) Recommended, to prevent the warewasher from scaling up.	≤ 31 °dH (37.6 °e / 53.4 °TH / 5.35 mmol/l)
	UC Excellence-i	≤ 35 °dH (43.9 °e / 62.3 °TH / 6.3 mmol/l)	-
	UC Excellence-iPlus	-	≤ 31 °dH (37.6 °e / 53.4 °TH / 5.35 mmol/l)
Water flow pressure	UC Standard, UC Cool	100 kPa (1.0 bar)	
	UC Energy	150 kPa (1.5 bar)	
	UC Excellence-i, -i(Plus)	140 kPa (1.4 bar)	
Max. inlet pressure (back pressure)	1000 kPa (10.0 bar)		
Flow rate	UC Standard, UC Cool, UC Excellence-i, -i(Plus)	min. 4 l/min	
	UC Energy	min. 3 l/min	

Threshold values for the raw water for UC Excellence-i(Plus)

Electrical conductivity (at 25°C)	< 1200 µS/cm
Chlorine	< 0.2 mg/l
Silicate (as SiO ₂)	< 30 mg/l

Waste water connection

Location	approx. 600 mm above finished floor; next to the machine
Construction	Trap on-site

5.2.2 Electrical connection



DANGER

Electric shock from live components

A fatal electric shock can occur when the warewasher and its additional devices are connected to the electrical mains supply.

- The warewasher and its additional devices may be connected to the electrical mains supply only by a specialist company registered within the electrical trade and approved by the energy supplier.
- All locally applicable standards and regulations must be observed during the connection to the electrical mains supply.
- A protective circuit must be connected properly.
- The electrical safety of this warewasher is guaranteed only if it is connected to a correctly installed protective circuit and a residual current circuit breaker.
- The circuit diagram must be observed.
- The warewasher may be operated only at the voltages and frequencies specified on the rating plate.
- For machines delivered without a plug, a fixed connection must be installed as an overriding priority.
- We recommend installing a mains isolation switch with all-pole disconnection from the mains supply in the case of a fixed connection (without plug) so as to be able to ensure the absence of voltage during installation and maintenance.
- The electrical connection must be secured as a separately fused circuit with slow fuses or circuit breakers. The fuse protection depends on the total connected load of the warewasher. The total connected load is specified on the rating plate of the warewasher.
- If a residual current circuit breaker is present on-site, we recommend installing a Class B all-current-sensitive residual current circuit breaker.
- Machines delivered from the factory that are fitted with mains cable and safety plug (single-phase), or a CEE plug (triple-phase), may only be connected to the mains network indicated on the nameplate. Machines may only be connected to an individually protected safety socket. Do not use extension cables or multi-socket adapters.
- Determine the cable cross-section of the mains cable using the following table:

Mains voltage	Frequency [Hz]	On-site fuse protection [A]	Cable cross-section [mm ²]
380 V - 415 V / 3N~	50 / 60	10 / 15 / 16 / 20	2.5
220 V - 240 V, 1N~	50 / 60	10 / 13 / 15 / 16 / 20	2.5
200 V, 2~	50 / 60	20	2.5
200 V, 3~	50 / 60	25	4
230 V, 2~	50 / 60	16	2.5
230 V, 3~	50 / 60	20 / 25	4

The mains cable must be a H07RN-F type or equivalent.

Connecting the mains cable

Note: Select the correct cross section and number of wires in the mains cable to suit the on-site voltage and fuse protection.

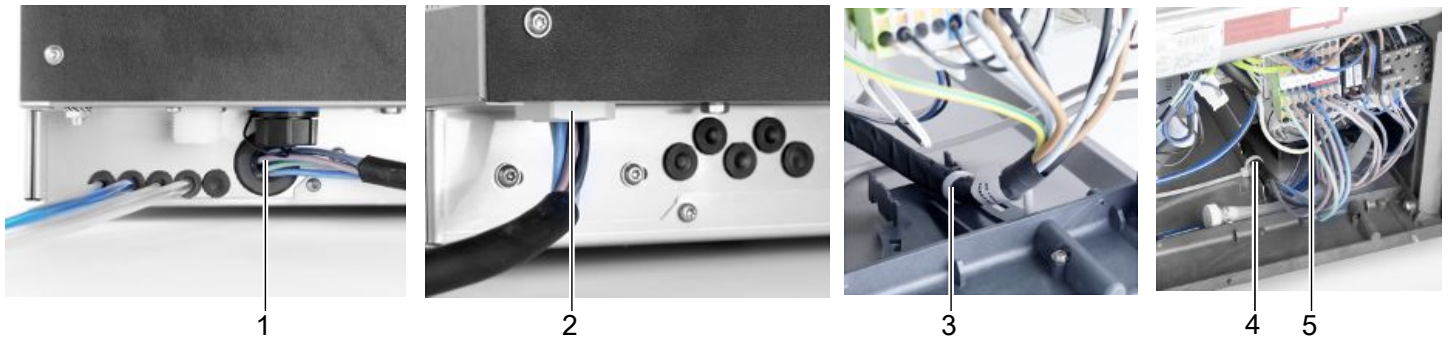

Item	Name	Note
1	Mains cable	UC-M, -L, -XL
2	Mains cable	UC-S
3	Strain relief	UC-S
4	Strain relief	UC-M, -L, -XL
5	Terminal strip	

- Remove the front cover.
- Insert the mains cable (1 / 2) at the rear of the machine.
- Pull out the mains cable at the front.
- Secure the mains cable to the strain relief on the mounting plate using a cable tie (3 / 4).
- Strip the wire end of the mains cable and attach ferrules.
- Observe the connection diagram affixed to the rear of the partition wall for the electrical installation compartment.
- Connect the mains cable wires (5) according to the connection diagram (see ► page 29).
- If necessary, install new bridges in accordance with the connection diagram and press in firmly using a screwdriver.
- Connect the green-yellow wire to the distributor of the earth wires.

Establishing equipotential bonding



- Connect the warewasher to the on-site equipotential bonding system.
- Position of the connecting screw (1) see drawing.

Connection diagram

Note: P545 (interlock) is configured by the service technician during menu-guided set-up.

Mains cable with star circuits

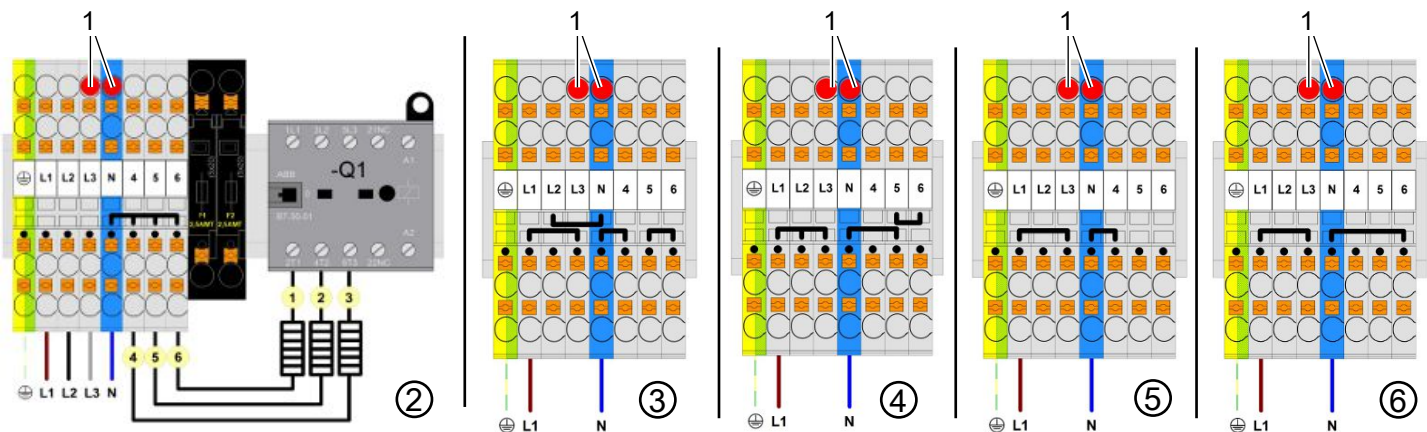

Item	Voltage			Parameter (P545)	Fuse (A)
1	Tank heating element connection				
2	380 V - 415 V	3N~	PE	0	16
				1	10
3	220 V - 240 V	N~	PE	1	16
4	220 V - 240 V	N~	PE	1	20
5	220 V - 240 V	N~	PE	1	13
6	220 V - 230 V	N~	PE	2	10

Mains cable for Australia

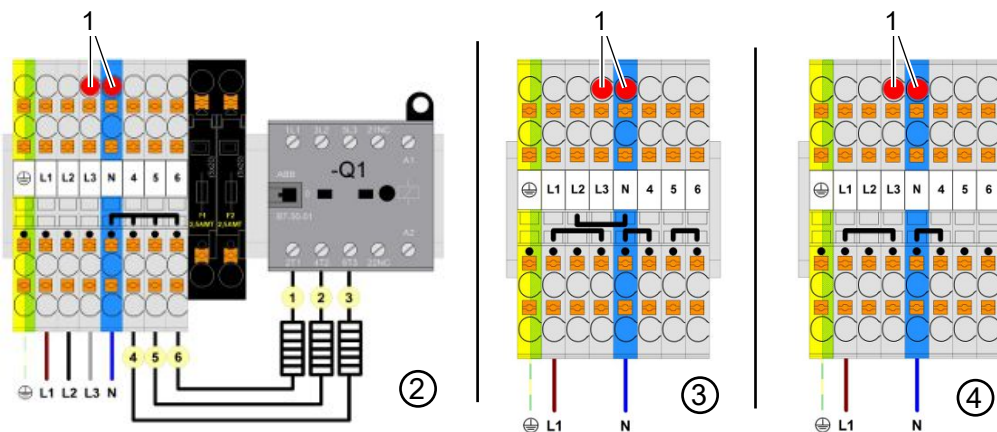

Item	Voltage			Parameter (P545)	Fuse (A)
1	Tank heating element connection				
2	380 V - 415 V	3N~	PE	0	20
				1	15
3	220 V - 240 V	N~	PE	1	20
4	220 V - 240 V	N~	PE	1	15

Mains connection with delta circuits (200 V)

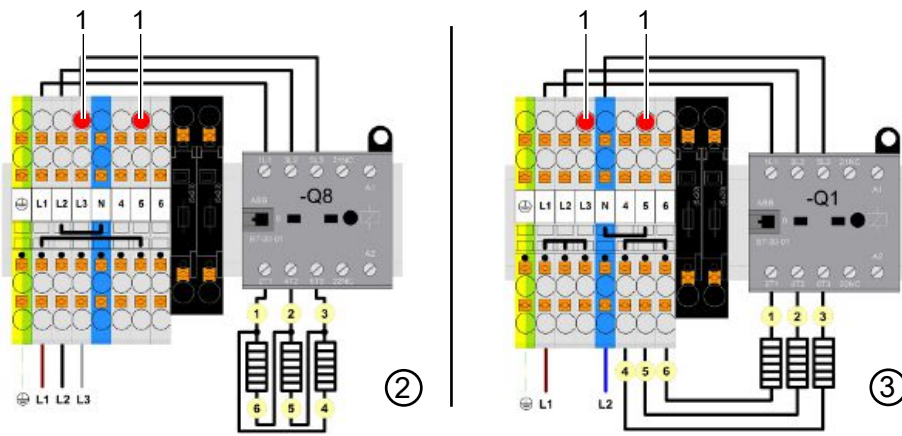

Item	Voltage	Parameter (P545)			Fuse (A)
1	Tank heating element connection				
2	200 V	3~	PE	0	25
3	200 V	2~	PE	1	20

Mains connection with delta circuits (230 V)

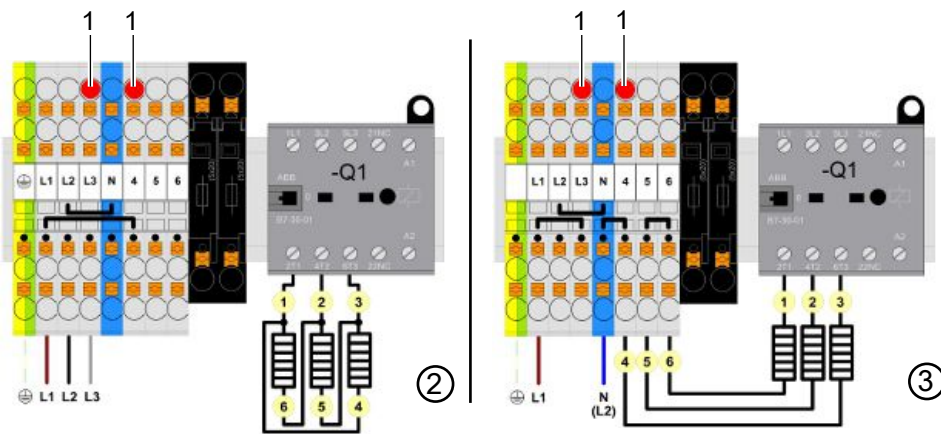

Item	Voltage	Parameter (P545)			Fuse (A)
1	Tank heating element connection				
2	230 V	3~	PE	0	25
				1	20
3	230 V	2~	PE	1	16

5.3 Connecting suction tubes and external dosing devices

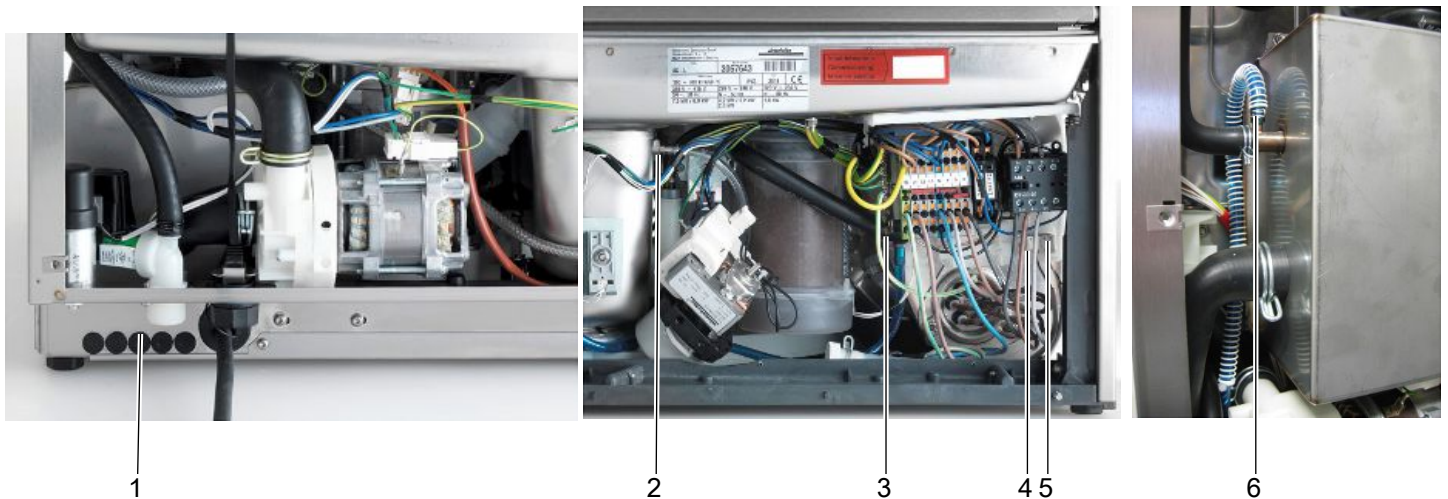

Item	Name	Note
1	Entries for hoses and cables	Rear view
2	Connection for detergent dosing hose	Front view
3	Connection for rinse aid dosing hose	UC-M, UC-L, UC-XL
4	Plug for detergent suction tube with empty indicator	White plugs
5	Plug for rinse aid suction tube with empty indicator	Blue plugs
6	Connection for rinse aid dosing hose	UC-S, rear view

- Disconnect the warewasher from the electrical mains supply and secure against unintended activation.
- Remove the front cover from the warewasher.
- Remove partition wall to the electrical installation area.
- Lead the dosing hose and the connection cable through at the intended point on the back of the warewasher chassis (1).
- Fasten the detergent dosing hose to detergent connection (2) with wire hose clip.
- Fasten the rinse aid dosing hose to the rinse aid connection (3 / 6) with a wire hose clip.
- Connect the connection cable of the suction tube on the plug (4 / 5).
- Ensure that the dosing hose and connection cable are guided kink-free.
- Install the partition wall to the electrical installation area.

5.4 Establish the electrical connection of the external dosing devices



DANGER

Electric shock from live components

A fatal electric shock can occur during installation and maintenance work and when carrying out repairs.

- Isolate and lockout the mains supply to the warewasher.
- Check that there is no voltage present.

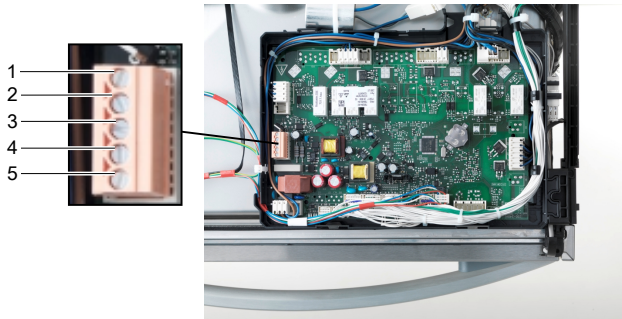

Note: Maximum current drain at the transfer strip: 0.5 A. Only connect external dosing devices with their own fuse protection. Include the dosing device in the protective circuit (PE) of the warewasher.

- Disconnect the warewasher from the electrical mains supply and secure against unintended activation.
- Connect external dosing device to transfer strip.
- Configure the transfer strip (▶ page 33).

Item	Name	Note
1	DETERGENT	For detergent dosing device (type-dependent)
2	WASH	For detergent dosing device (type-dependent)
3	RINSE	For rinse aid dosing device
4	N	Neutral / phase 2
5	L1	Continuous voltage / phase 1

Depending on the configuration of the transfer strip, voltage is present at the RINSE and DETERGENT terminals.

Terminal	Voltage present	Condition	Restriction
DETERGENT	While machine fills	<ul style="list-style-type: none"> – Door closed – Minimum water level in the tank 	
	Parallel to solenoid valve <ul style="list-style-type: none"> – While machine fills – During the rinse 	<ul style="list-style-type: none"> – Door closed 	<ul style="list-style-type: none"> – Not during the self-cleaning programme
WASH	Parallel to wash pump	<ul style="list-style-type: none"> – Door closed 	<ul style="list-style-type: none"> – Not during the self-cleaning programme – Not while the machine is being filled – Not during the descaling and basic cleaning programme
RINSE	Parallel to rinse pump	<ul style="list-style-type: none"> – Door closed 	<ul style="list-style-type: none"> – Not during the self-cleaning programme – Not while the machine is being filled – Not during the descaling and basic cleaning programme
	Parallel to solenoid valve <ul style="list-style-type: none"> – While machine fills – During the rinse 	<ul style="list-style-type: none"> – Door closed 	<ul style="list-style-type: none"> – Not during the self-cleaning programme

5.5 Configuring the transfer strip

A service technician configures the transfer strip in the Dosing menu, specifying the type of dosing device.

Detergent dosing device

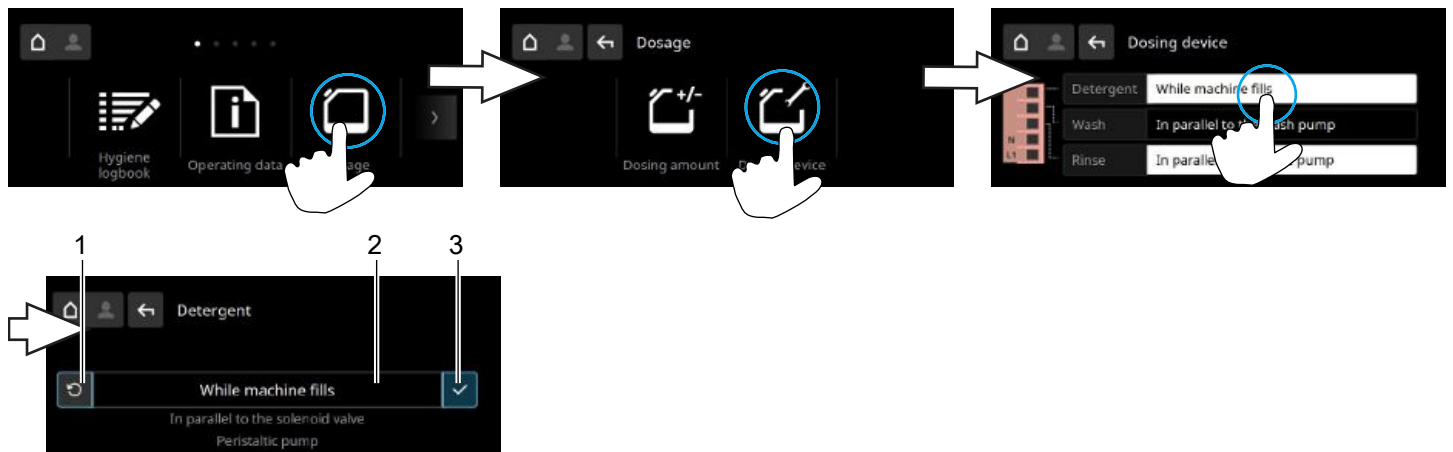

Item	Name	Note
1	Reset to default setting	
2	For dosing devices not from Winterhalter: <ul style="list-style-type: none"> – While machine fills – Parallel to the solenoid valve – Peristaltic pump For Winterhalter dosing device: <ul style="list-style-type: none"> – Fluidos – MPI/PPX 	With the “peristaltic pump” setting, set the output in ml/min. Set the dosing amount in the dosing menu.
3	Save settings	

Rinse aid dosing device

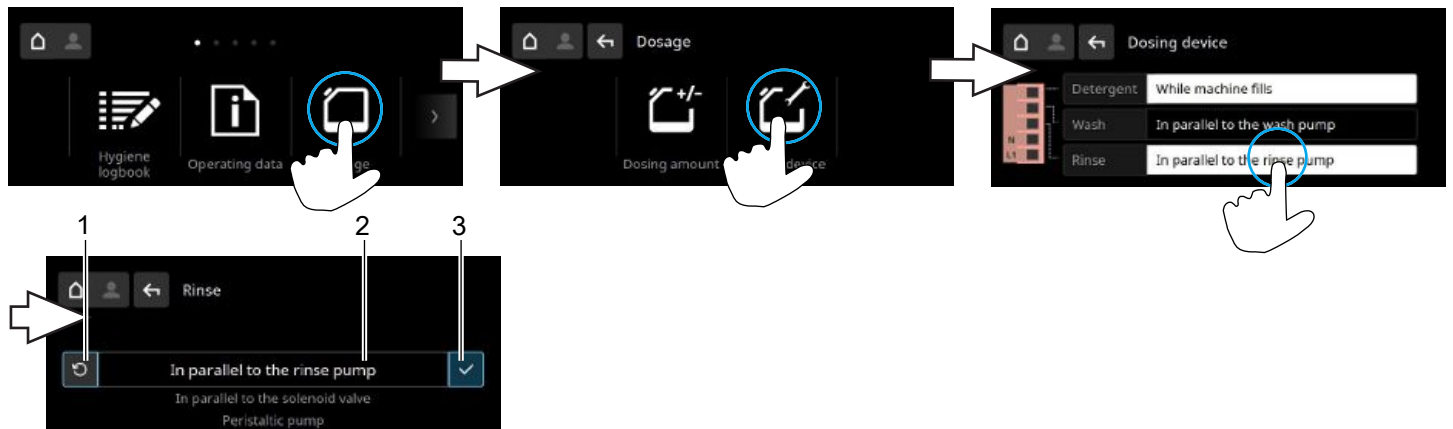

Item	Name	Note
1	Reset to default setting	
2	For dosing devices not from Winterhalter: <ul style="list-style-type: none"> – Parallel to the rinse pump – Parallel to the solenoid valve – Peristaltic pump For Winterhalter dosing device: <ul style="list-style-type: none"> – Fluidos – MPI/PPX 	With the “peristaltic pump” setting, set the output in ml/min. Set the dosing amount in the dosing menu.
3	Save settings	

5.6 Before working with the warewasher for the first time

- Arrange for the warewasher to be set up by an authorised service technician or by your dealer.
- Arrange for the warewasher to be connected by authorised technicians according to the locally applicable standards and regulations (water, waste water, electrical system).
- After connecting the water and the power properly, contact the relevant Winterhalter dealership or your dealer to arrange for commissioning of the warewasher. Arrange for the operator and operating personnel to be trained in operating the warewasher.

5.7 Putting a preserved warewasher back into service

Note: Only for Excellence-i(Plus) warewashers with an integrated reverse osmosis module.

For warewashers with preserved membranes in the reverse osmosis module, the preserving agent must be rinsed off during recommissioning.

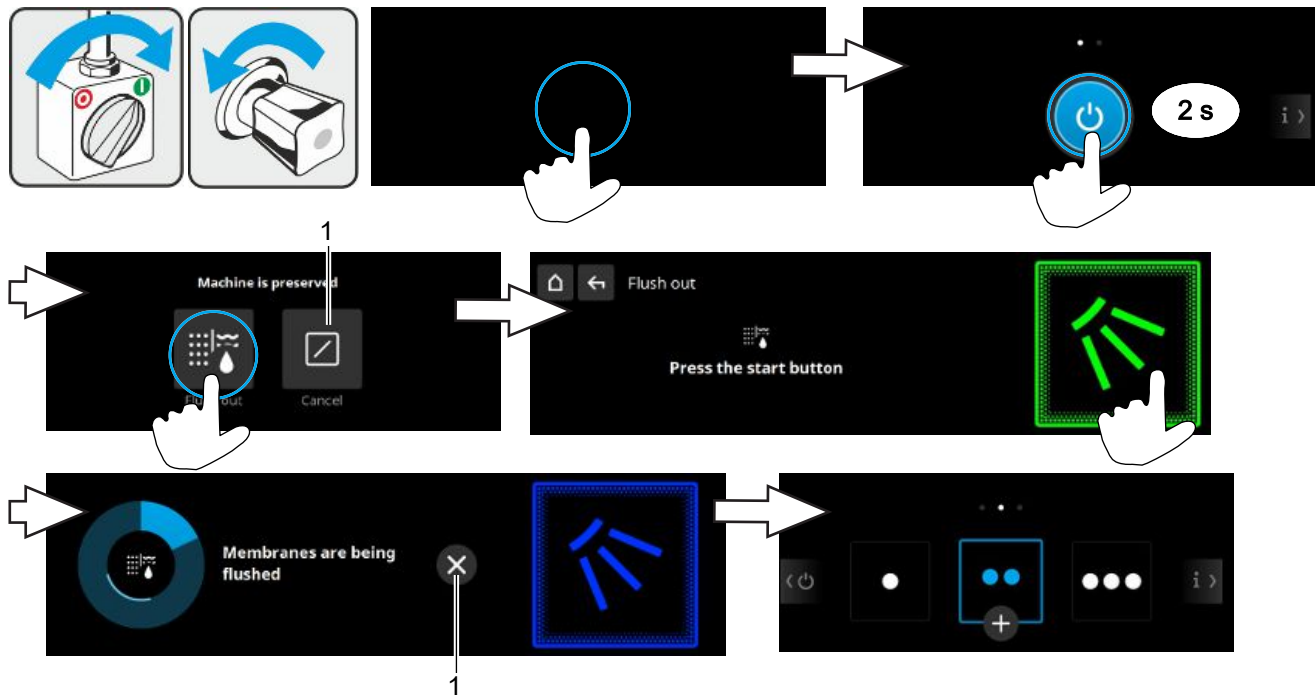

Item	Name
1	Cancel the programme

- Set the date and time (► page 23).
- Check whether it is necessary to replace the activated carbon filter (see date entry on the activated carbon filter). The maximum service life is one year.

6 Operation

6.1 Switch on the warewasher

The warewasher is ready for operation as soon as the start button lights up green.

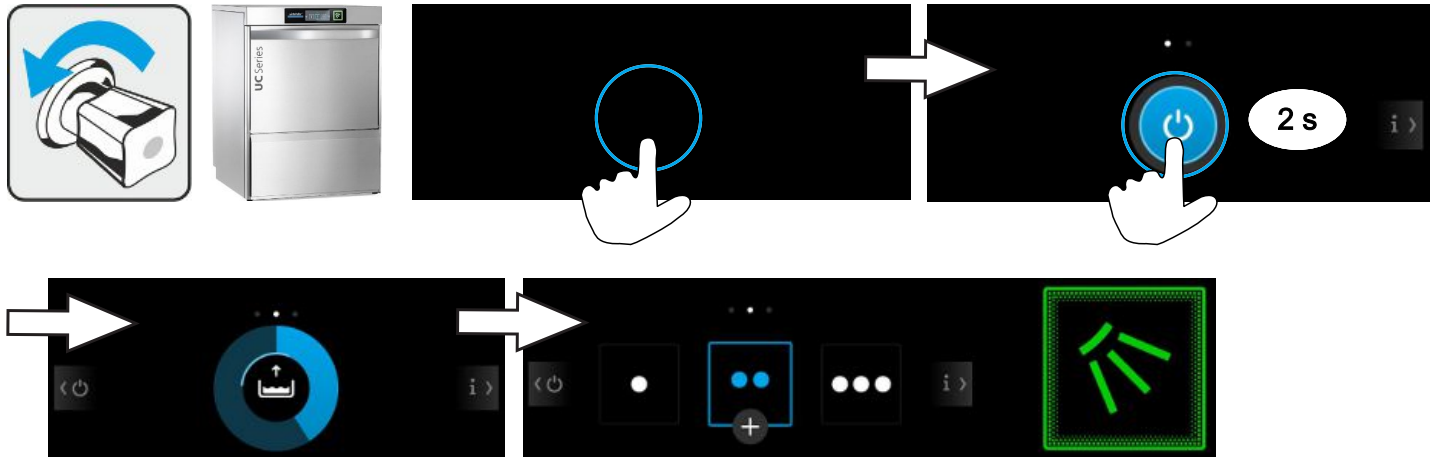

6.2 Check for completeness

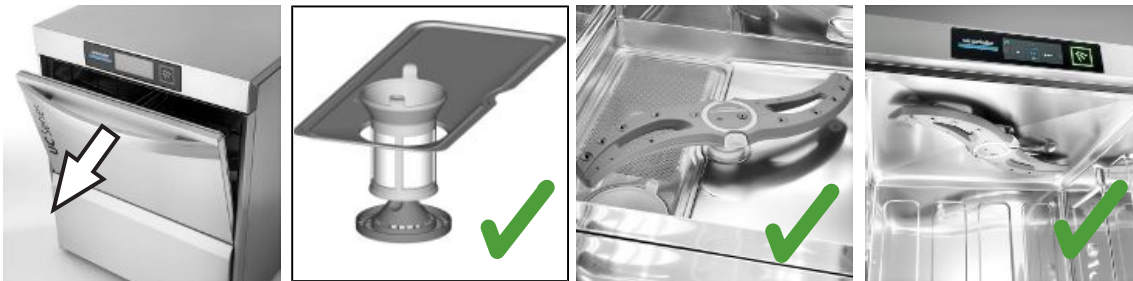

Note: Ensure that there is always enough detergent and rinse aid available to achieve an optimum wash result.

6.3 Washing



CAUTION

Risk of scalding from hot wash water

- Do not open the door during washing.
- Before opening the door, terminate the washing programme by pressing the start button and waiting a few seconds.

- Do not wash without a wash rack.
- Do not wash electrical cooking appliances.
- Do not wash parts made of wood.
- Do not wash ashtrays or objects covered with wax.
- Only wash heat-resistant plastic parts and those resistant to alkalis.

Instructions for a good wash result

- Soak the cutlery until it is clean. Do not use any foaming pre-cleaners.
- Do not polish glasses, cutlery or dishes. Germs and bacteria can be found even in fresh multi-purpose cloths.
- Wash parts made of aluminium, e.g. pots, containers or trays, only with a suitable detergent to avoid black discoloration.

Arranging the wash items in the wash rack

- Remove large pieces of food residues.
- Pour out beverage residues (outside the warewasher).
- Place plates with their upper surface facing forwards.
- Place glasses, cups, bowls and pots rim down.
- **CAUTION! Possible risk of injury from sharp or pointed utensils when loading the wash racks!** Wash cutlery upright in the cutlery holder or lying in the shallow wash rack. Always arrange the handle ends downwards. Make sure that the cutlery is well-spaced.
- Do not overload racks, so that the wash water can reach all dirty surfaces.
- Space glasses to prevent them from rubbing against each other. This will avoid scratches.
- For tall glasses, choose a wash rack with appropriate divisions so that the glasses are held in a stable position.

Starting the washing programme

- Arrange the wash rack correctly.
- Open the door.
- Slide the wash rack into the warewasher.
- Close the door.
- Press the start button (1).
 - ⇒ Start button turns blue.
 - ⇒ For warewashers with an Energy module, the start button flashes blue-green before the end of the programme. At the same time, the warm and humid air is extracted from the interior, and the heat energy stored in it is recovered for the next washing programme.
 - ⇒ Start button flashes green as soon as the washing programme ends.
- Do not open the door until the start button (1) flashes green.

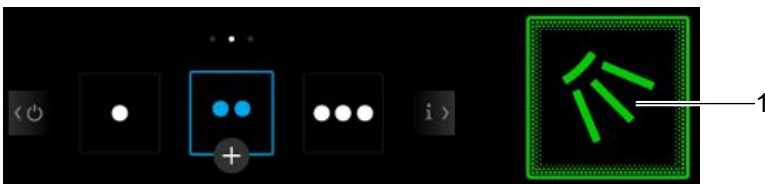

Cancelling the washing programme



- Press button (1) or (2).
 - ⇒ The start button lights up green.

Wash breaks

- Do not switch the warewasher off during wash breaks.
- Close the door to prevent the machine from cooling down.

Activating an additional programme

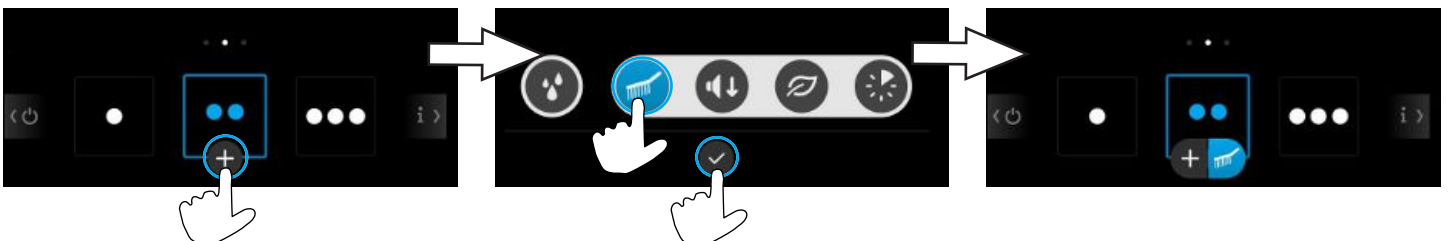

The additional programme remains activated until it is deactivated or another additional or washing programme is selected.

Deactivating the additional programme

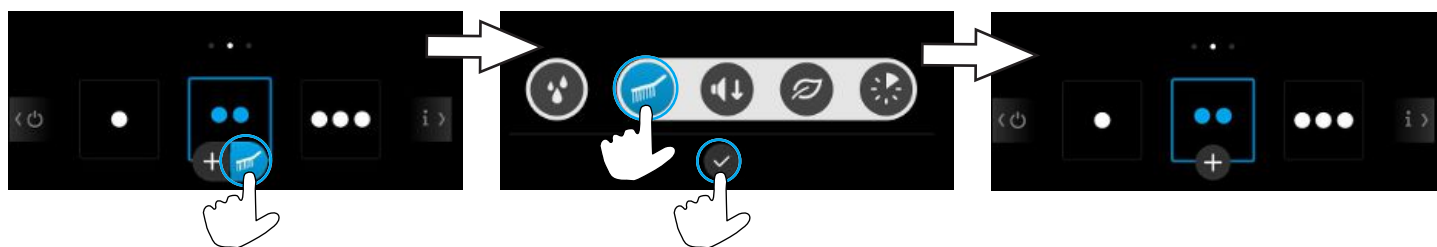

6.4 Soaking programme

We recommend the soaking programme for soaking and dissolving dried-on residues.

Activating the soaking programme

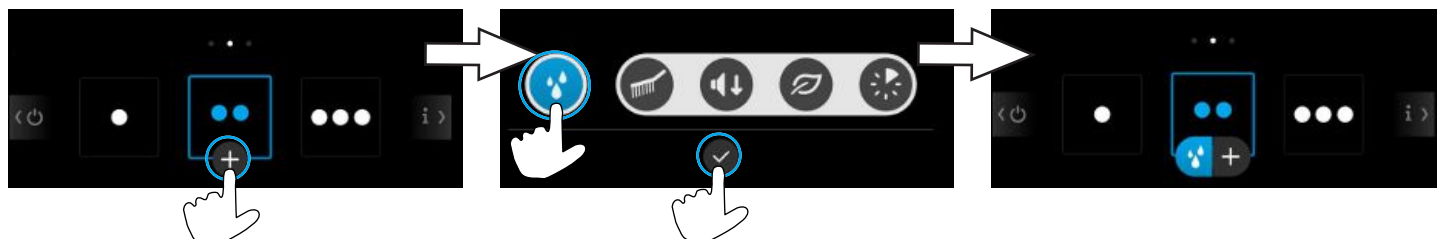

The soaking programme remains activated until it is deactivated and can be combined with another additional programme.

Starting the soaking programme



WARNING

Risk of chemical burns due to chemicals

Contact of chemicals with the skin or eyes can lead to severe burns or serious eye damage.

- In the event of contact with the eyes or skin, wash thoroughly with tap water. If necessary, seek medical attention.
- Wear protective clothing, protective gloves and protective goggles.
- Observe the danger and safety notes on the canister and safety data sheet.

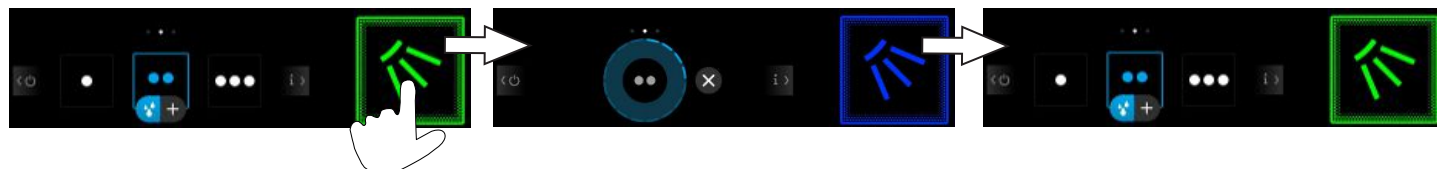

Five seconds after the soaking programme has started, the wash pump circulates the tank water for seven seconds. The soaking time of five minutes begins after this circulation. The tank water moistens the wash items and soaks the contaminants.

- If you open the door during this time and close it again within 10 seconds, the wash pump circulates the tank water again for five seconds. The soaking time is not extended.
- If you open the door for longer than 10 seconds to put more wash items into the washing basket, the soaking programme will start from the beginning once the door has been closed. A washing programme starts automatically after the end of the soaking period. The soaking period can also be shortened by pressing the start button.

A service technician can adjust the times mentioned above.

- Remove the wash items only once the washing programme has finished and the start button flashes green.

Cancelling the soaking programme

After cancelling the soaking programme, always start a washing programme to rinse the tank water off the wash items.

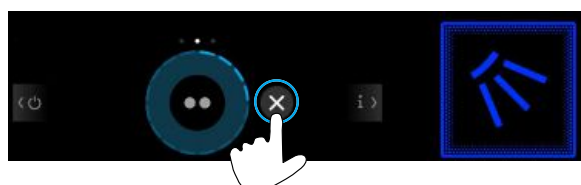

Deactivating the soaking programme

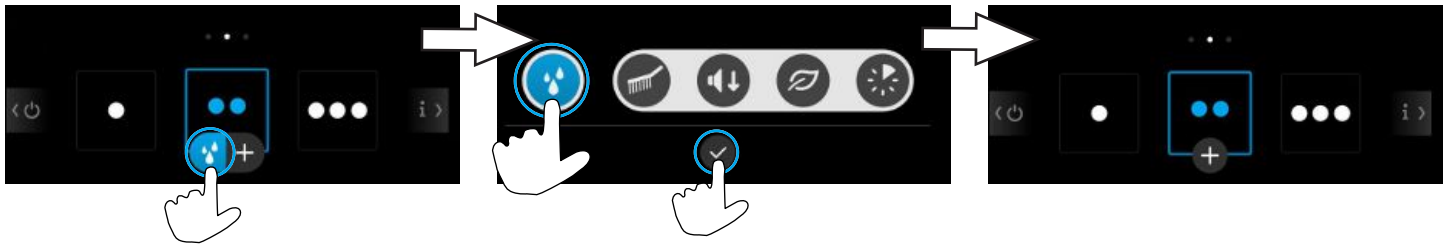

6.5 Changing the tank water

Change the tank water if it is very dirty and if the end wash result worsens.

Note: It takes a few minutes until the warewasher is ready for operation again, as the tank is first emptied and then refilled and reheated.

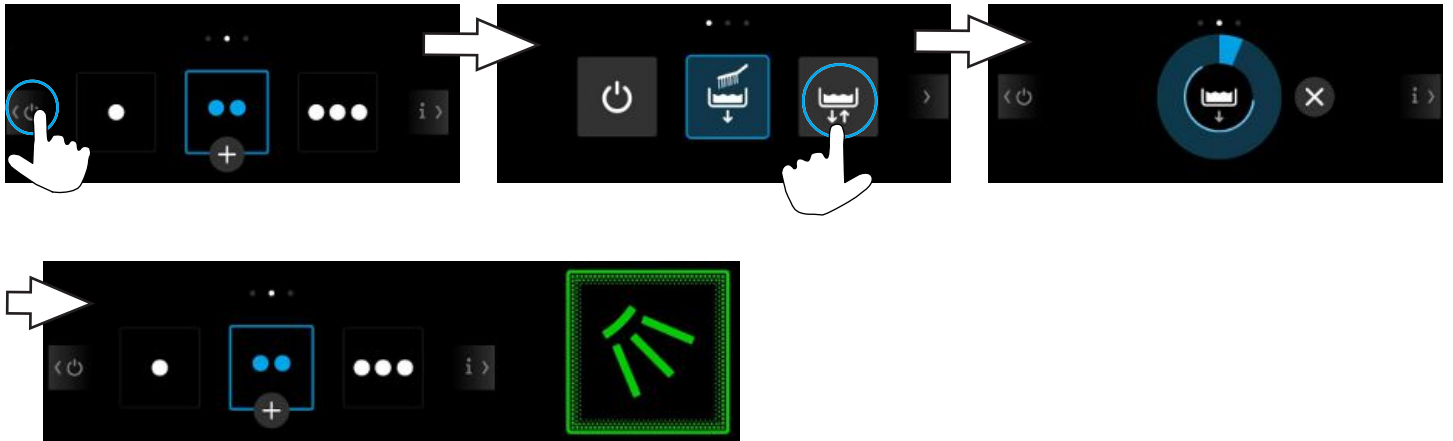

6.6 Switching off the warewasher

We recommend switching off the warewasher at the end of the working day with the self-cleaning programme (► page 41) so that it is cleaned and emptied each day.

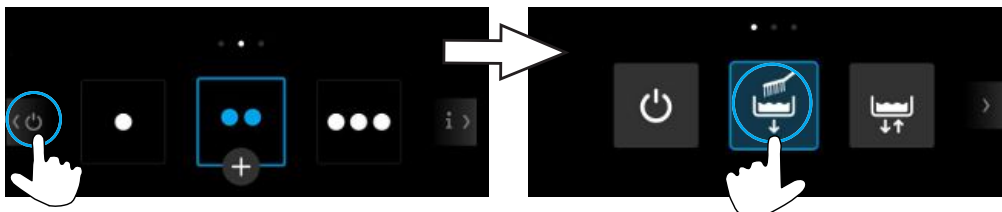

Pressing the On/Off button switches the warewasher off. The tank stays filled but will no longer be kept at temperature. If the tank temperature has dropped too much before the machine is switched on again, the machine will be emptied and refilled automatically.

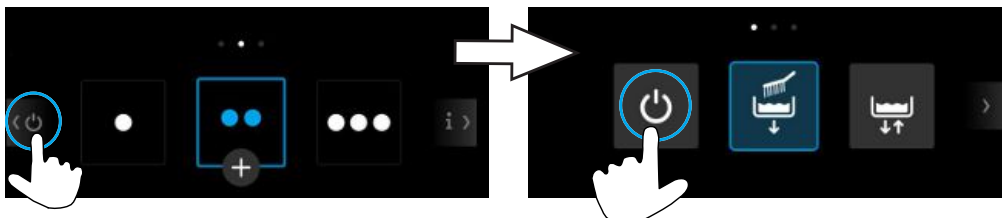



















7 Notifications

7.1 Pictograms

Notifications are displayed as pictograms. If there are many notifications, washing will still be possible but the end wash result will be impaired. Please therefore rectify any notification as soon as possible. If you cannot rectify the notification, contact an authorised service technician.

By tapping the pictogram, additional information will appear on the display.

Cause / meaning	Remedy
 Lack of rinse aid	Fill integral storage tanks (▶ page 44) or replace the canister (▶ page 45) and prime the dosing device.
 Lack of detergent	
 Upper wash field does not rotate	Remove the obstruction or clean or descale the jet (▶ page 41). Contact an authorised service technician.
 Lower wash field does not rotate	Ensure the wash field is engaged correctly. Remove the obstruction or clean or descale the jet (▶ page 41). Contact an authorised service technician.
 For warewashers with an integrated softener: Lack of salt	Fill the salt container with regeneration salt. The display disappears after filling the salt container after approx. 3 wash cycles have been completed and some of the salt has dissolved.
Warewasher with external partial demineralisation cartridge: Partial demineralisation cartridge used up	Replace the partial demineralisation cartridge. Reset the water countdown meter (▶ page 24).
Warewasher with external full demineralisation cartridge: Full demineralisation cartridge used up	Have the resin of the full demineralisation cartridge replaced by an authorised service technician. Reset the water countdown meter (▶ page 24).
 Open the door	Close the door.
 Lack of water	Open the water supply. Have the dirt trap cleaned by a service technician or have a new dirt trap installed. Have the solenoid valve repaired by an authorised service technician.
 Energy optimisation active	Wait until the local energy optimisation activates the warewasher.
 Service interval expired	Contact an authorised service technician.
 Strainer clogged	Clean the strainer and restart the programme.
 Descaling required	Start the descaling programme (▶ page 22).
 Error in external water treatment device	Check the water treatment device.
 Energy saving warning	Close the door.
 Various	Tap the pictogram and note the error code. Contact an authorised service technician.
 Reverse osmosis deactivated	Contact an authorised service technician.
 Activated carbon filter used up	Change the activated carbon filter (▶ page 46) and reset the activated carbon counter (▶ page 24).
 A0-30 wash cycle cancelled	Hygiene in accordance with A0 requirements not guaranteed. Restart the A0 washing programme.
 A0-60 wash cycle cancelled	

7.2 Display the error code for a serious error

If a serious error occurs, washing is no longer possible and a red bar appears at the top of the display:

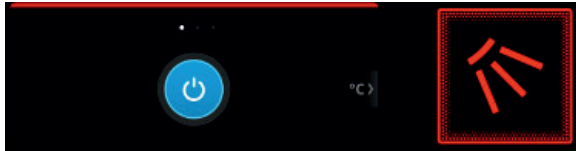

Accessing the error code

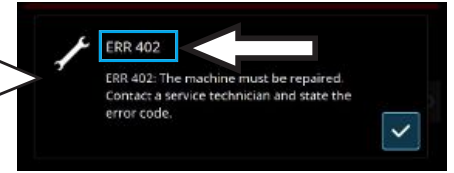
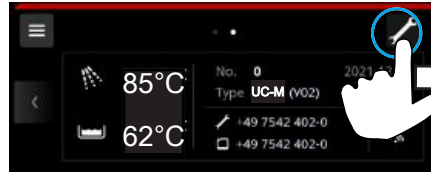

7.3 Poor wash result

	Possible cause	Remedy
Wash items not clean	No or low detergent dosing	Set the dosing amount as per the manufacturer's specifications (▶ page 17). Check the dosing hose (for kinks, breakage, etc.). Prime the dosing device (▶ page 45). Replace the canister, if empty.
	Wash items incorrectly sorted	Arrange wash items correctly (▶ page 36).
	Wash field jets clogged	Dismantle wash field and clean jets. (▶ page 42).
	Temperatures too low	Check the temperature (▶ page 13).
	Tank water too heavily soiled	Start the tank water exchange programme (▶ page 38).
Spots visible on the wash items	If scaling is present: the water is too hard	Check the external water treatment. Connect the water treatment device.
	For starch residues: Temperature of manual pre-cleaning is above 40°C	Carry out basic cleaning. Lower the temperature of manual pre-cleaning.
The wash items do not dry on their own	No or low rinse aid dosing	Set the dosing amount as per the manufacturer's specifications (▶ page 17). Check the dosing hose (for kinks, breakage, etc.). Prime the dosing device. Replace the canister, if empty.
	Rinse temperature too low	Contact an authorised service technician.

Note: Water quality affects the washing and drying result. We therefore recommend that, upwards of a total hardness of more than 3 °dH (0.53 mmol/l), the warewasher be supplied with softened water.

8 Cleaning and maintenance

The following materials must **not** be used for cleaning:

- High-pressure cleaner, steam jet
- Detergents containing chlorine or acid
- Cleaning sponges or wire brushes containing metal
- Abrasives or abrasive cleaning agents

8.1 Cleaning the warewasher at the end of the working day

Self-cleaning programme

The self-cleaning programme is helpful for cleaning the inside of the warewasher at the end of the work day. We recommend that you also use A 15 MC cleaning tablets. The A 15 MC cleaning tablets help to remove unpleasant odours and light limescale deposits.

After the first programme step, the self-cleaning programme is interrupted and a video with further steps is shown on the display. If no notice is taken of the video, the self-cleaning programme will start automatically.

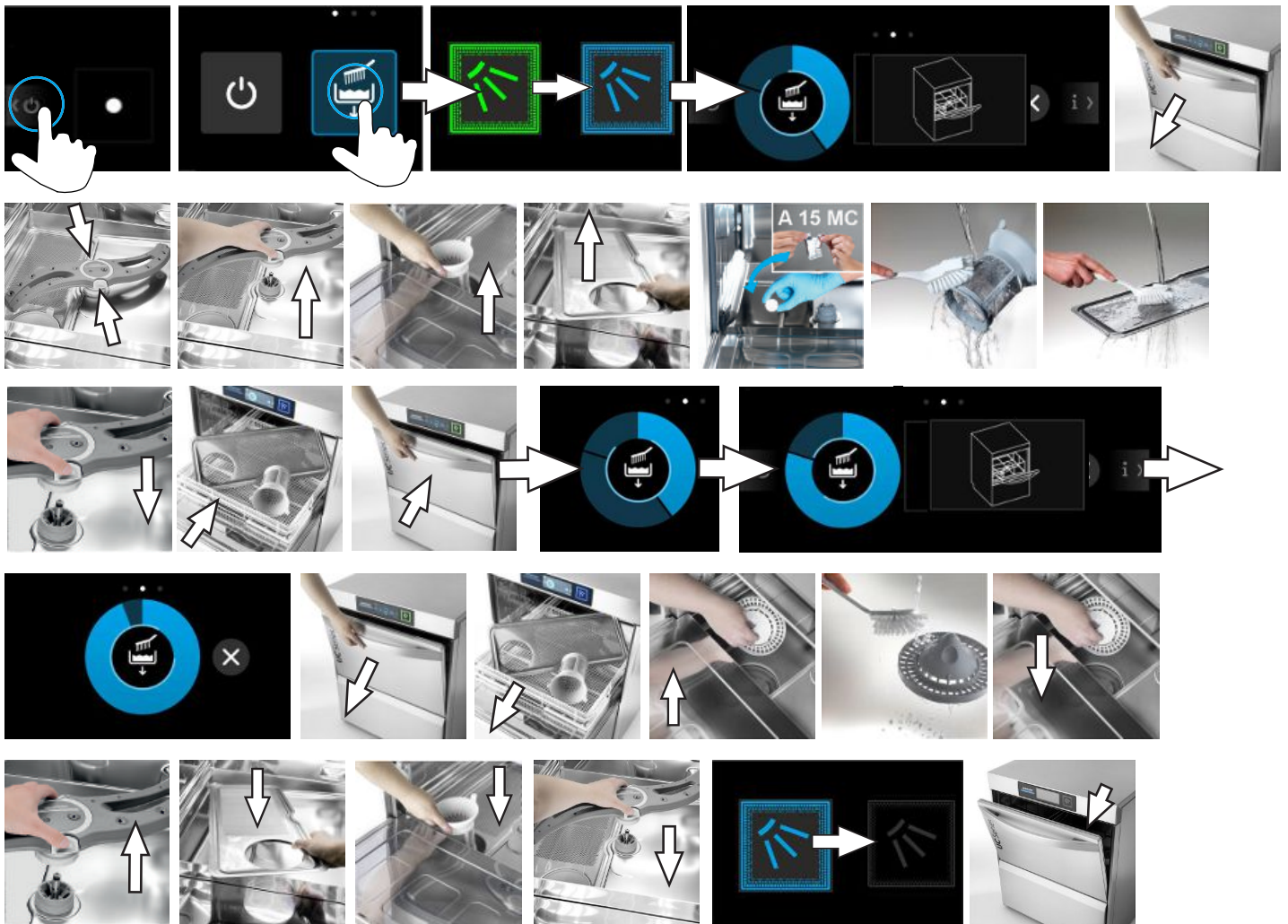

Cancelling the self-cleaning programme

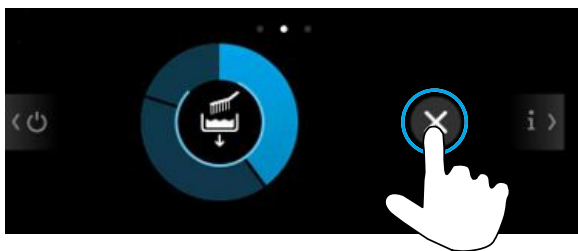

Cleaning the warewasher interior

Ensure that there are no rusty foreign objects in the interior of the warewasher, which could cause even “rust-free stainless steel” to corrode. Rust particles can come from non-rust-free wash items, from cleaning aids, damaged wire grate racks or from water pipes that are not protected against rust.

To achieve an optimal wash result and to increase the service life of the warewasher, we recommend cleaning the interior daily.

- Remove dirt with a brush or cloth.

Cleaning the outside of the warewasher

- Do not spray the warewasher and the surrounding area (panels, floor) with a steam jet or high-pressure cleaner. Ensure when cleaning the floor that the plinth of the warewasher is not flooded, to prevent an uncontrolled inflow of water.
- Clean the display with a damp cloth.
- Clean the external surfaces using a stainless steel cleaner and stainless steel polish.

Cleaning the upper and lower wash field



After cleaning



8.2 Topping up the regeneration salt



NOTE

Damage to the water softener

Chemicals such as detergent or rinse aid and other salts such as table salt or thawing salt will inevitably damage the water softener.

- Fill only with regeneration salt or a pure evaporated salt with a maximum grain size of 0.4–7 mm.
- Only fill with water when commissioning the water softener for the first time.
- Top up the regeneration salt.
- **Note: Danger of rust formation in the filling area as a result of salt residues!** After filling the regeneration salt, start a washing programme or the self-cleaning programme in order to wash away any salt residues that may be present. We recommend starting the self-cleaning programme, as salt residues can have a negative impact on the wash result.

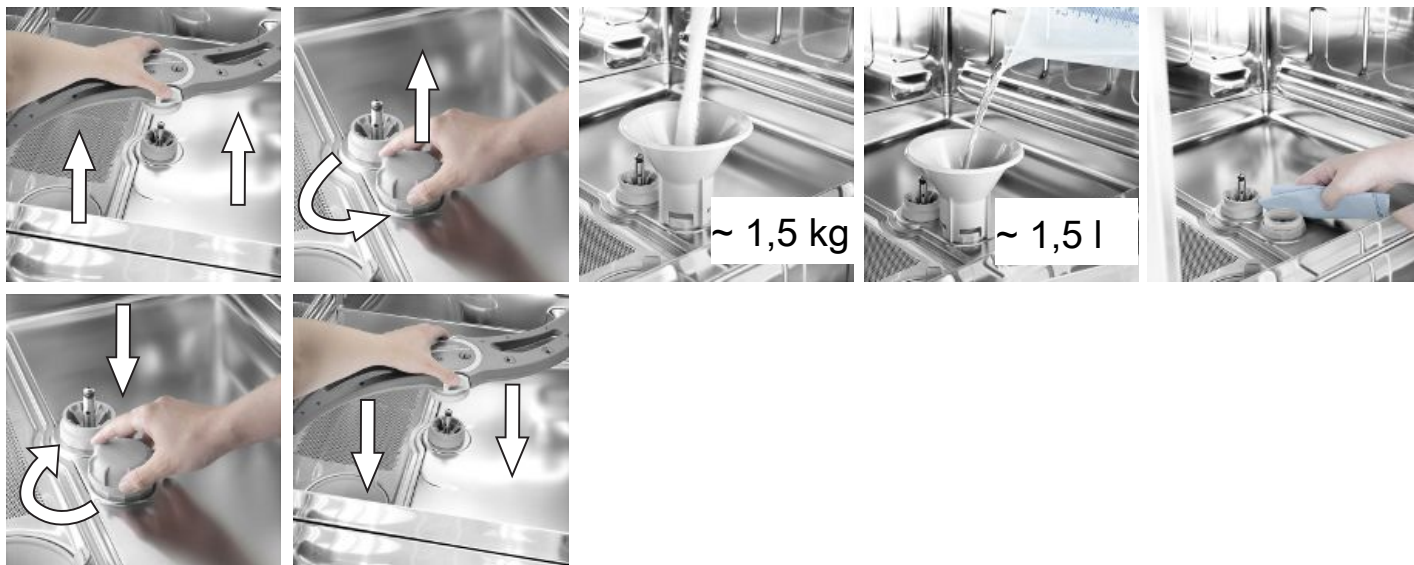

8.3 Refilling the detergent and rinse aid



WARNING

Risk of chemical burns when handling chemicals

- Observe the danger and safety notes on the canister and safety data sheet.
- Wear protective clothing, protective gloves and protective goggles.

Note: Only for machines with an integral storage tanks.



Flap colour	Storage container
White	Detergent
Blue	Rinse aid

- Wear protective clothing, protective gloves and protective goggles.
- Only add detergent to white storage tank for detergent.
- Only add rinse aid to blue storage tank for rinse aid.
- Wash the funnel in the machine after use to remove any chemical residues.
- Prime the dosing devices (▶ page 45).

8.4 Replacing the canister



WARNING

Risk of chemical burns when handling chemicals

- Observe the danger and safety notes on the canister and safety data sheet.
- Wear protective clothing, protective gloves and protective goggles.

Note: Only for machine with external canisters.

A suction tube is needed to suck out the chemicals from the canisters.

- Do not place the suction tube for the rinse aid in the canister with detergent or vice versa.
- Only use the suction tube with sufficiently stable canisters. Narrow and tall canisters can tip as soon as the suction tube is pulled.
- Do not pull on the dosing hose or main power cable, as this may lead to a defect.

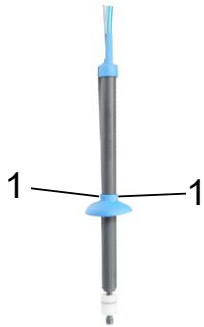

- Wear protective clothing, protective gloves and protective goggles.
- Pull the suction tube carefully out of the empty canister.
- Check whether both vent holes (1) in the caps are open. Clean if required.
- Place suction tube in the new canister.
- Slide the cap slowly downwards until the canister opening is closed.
- Prime the dosing device.

Priming the dosing devices

The dosing device must be primed if air has entered the dosing hose. This occurs if the canister is not replaced in time.

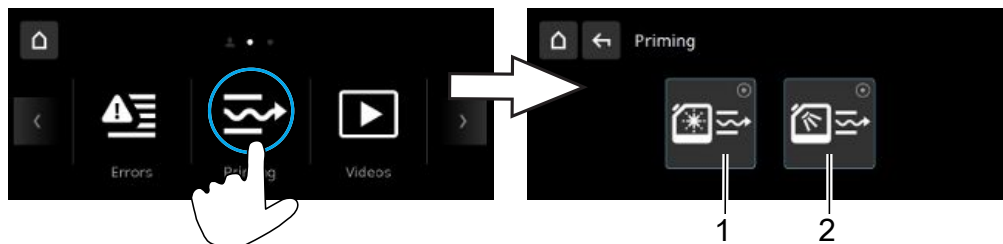

Item	Name
1	Rinse aid dosing device
2	Detergent dosing device

- Press button 1 or 2.
 - ⇒ The button turns white.
 - ⇒ The dosing device is being primed.
- As soon as the button goes off again, exit the menu.

8.5 Changing the chemical product

Crystallisation can occur as a result of mixing different chemical products, which can damage the dosing device. The dosing device and the dosing hoses must therefore be flushed with water before a new chemical product is used. If this is not done, the Winterhalter Gastronom GmbH warranty and product liability will be void.

For machines with integral storage tanks

- Have chemical products replaced by an authorised service technician.

For machines with external canisters and suction tubes

- Remove the suction tube from the canister and place it in a water-filled container.
- Rinse the dosing device with water via the “Priming” menu.

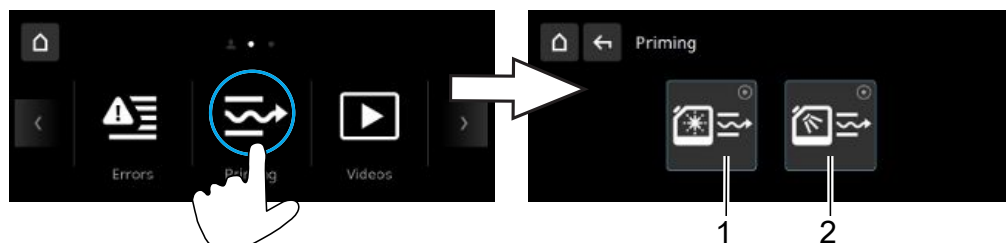

Item	Name
1	Rinse aid dosing device
2	Detergent dosing device

- Press button 1 or 2.
 - ⇒ The button turns white, and the dosing device is activated.
 - ⇒ The dosing hoses and the dosing device are rinsed out with water.
- As soon as the button goes off, insert the suction tube into the new canister.
- Press button 1 or 2 again.
 - ⇒ The button turns white, and the dosing device is activated.
 - ⇒ The water in the dosing hoses and dosing device is replaced by the new chemical product.

The dosing must also be reset.

- Use an authorised service technician to continue to attain good wash results.

8.6 Descaling the warewasher

If the warewasher is operated with hard water and without water treatment, then the boiler, the interior of the machine, all the water lines and components may develop scale. Limescale deposits and dirt that remain in the machine can contribute towards hygiene risks, while scaling can lead to failure of heating elements. In case of limescale deposits, the warewasher must be descaled.

Using the descaling programme (▶ page 22), scale is removed from the inside of the warewasher. We recommend running the descaling programme at the end of the working day only, as the machine's tank is emptied when the programme starts and ends.

The water lines and the boiler can only be descaled by an authorised service technician.

8.7 Changing the activated carbon filter

Note: Only for Excellence-i(Plus) warewashers with an integrated reverse osmosis module.

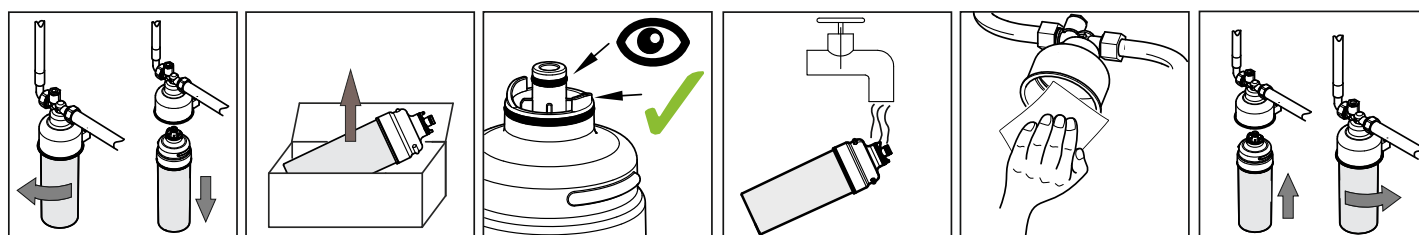

- Reset the activated carbon filter counter (▶ page 24).

8.8 Maintenance by the customer service department

We recommend that you have an authorised service technician carry out maintenance of the warewasher at least once a year so that vulnerable components subject to ageing and wear can be checked and replaced accordingly. Original spare parts must be used for repairs or to replace consumable parts.

Consumable parts include:

- Dosing tubes
- Inlet water hose
- Door seal
- Excellence-i(Plus) (optional): reverse osmosis module membranes
- Excellence-i(Plus) (optional): activated carbon filter



Service interval

The warewasher control unit specifies the number of operating hours or wash cycles at which the pictogram for service is shown.

Note: This function is deactivated ex-works. On request, the service technician can activate this function.

9 Disassembly and disposal

9.1 Taking the warewasher out of operation for long production stops

If the warewasher is taken out of operation for long periods (company holidays, seasonal operation), carry out the following steps:

- Have the dosing devices rinsed with water by a service technician and allow them to dry. If necessary, observe the dosing device information provided by third-party manufacturers.
- Use the self-cleaning programme to empty the warewasher.
- Clean the warewasher.
- Open the door.
- For Excellence-i(Plus) warewashers: If the period of disuse lasts longer than 28 days, have the membrane of the reverse osmosis module preserved by a service technician. **Note: The maximum preservation time for the membranes of the reverse osmosis module is 9 months, after which time the preservation must be renewed. In a preserved state, the warewasher can be stored at temperatures as low as -10 °C.**
- Switch off the local water supply.
- Disconnect the warewasher from the electrical mains supply.
- Empty the water treatment unit (e.g. partial demineralisation cartridges).
- Instruct an authorised service technician to secure the warewasher against frost.

9.2 Disassembly

- Remove any wash items and baskets from the warewasher.
- Empty the warewasher completely.
- Disconnect the warewasher from the electrical mains supply.
- Disconnect the warewasher from the local water supply.

9.3 Disposal

Incorrect or negligent disposal can cause considerable environmental pollution and/or damage.



- For hazardous substances, please observe the disposal regulations on the safety data sheets.
- Disposal according to national regulations.

Winterhalter Gastronom GmbH
Gewerbliche Spülsysteme

Winterhalterstr. 2-12
88074 Meckenbeuren
Deutschland

Tel. + 49 7542 402-0

www.winterhalter.de
info@winterhalter.de

Winterhalter Gastronom GmbH
Commercial Dishwashing Systems

Winterhalterstr. 2-12
88074 Meckenbeuren
Germany

Telephone: +49 (0) 7542 4 02-0

www.winterhalter.com
info@winterhalter.com